

# ENVISION™

## SERVICE AND PARTS MANUAL

Ambient and Refrigerated Models

MODELS

(S)nack

(C)ombo

(B)everage

ENV5



ENV4



700 Seaga Drive, Freeport, IL 61032, U.S.A.  
visit: [seaga.com](http://seaga.com) | email: [info@seaga.com](mailto:info@seaga.com)

ONE SOURCE ALL SOLUTIONS

## **INTRODUCTION**

Congratulations on the purchase of your EnVision vending machine. This vending machine has been designed to give you many years of dependable service. It requires little maintenance and is easy to set up and operate.

## **READ THIS MANUAL COMPLETELY**

Your vending machine is designed to operate simply and reliably, but to take full advantage of your vendor, please read this owner's manual thoroughly. It contains important information regarding installation and operations, as well as a brief trouble- shooting guide.

## **EQUIPMENT INSPECTION**

After you have received your vendor and have removed the packaging, place it on a secure surface for further inspection. Note: Any damages that may have occurred during shipping must be reported to the delivery carrier immediately. Reporting damages and the seeking of restitution is the responsibility of the equipment owner. The factory is willing to assist you in this process in any way possible. Feel free to contact our Customer Care Department with questions you may have on this process.

It is important that you keep the original packaging for your vending machine at least through the warranty period. If your machine needs to be returned for repair, you may have to purchase this packaging if it is not retained.

Once you have your vendor located, we suggest that you keep this manual for future reference, or you can view this manual online at [www.seaga.com](http://www.seaga.com). Should any problems occur, refer to the section entitled "TROUBLESHOOTING". It is designed to help you quickly identify a problem and correct it.



[seaga.com](http://seaga.com)

Seaga Manufacturing, Inc.  
700 Seaga Drive Freeport, IL 61032 U.S.A.

815.297.9500 Option 1  
815.297.1758 Fax  
email: [customercare@seaga.com](mailto:customercare@seaga.com)

## Table of Contents

INTRODUCTION	2
SPECIFICATIONS	4
CAUTIONS	9
LOADING PRODUCTS	10
PRODUCT PUSHERS	11
LOADING BAGGED OR BOXED ITEMS	11
REFRIGERATION	12
REFRIGERATION STATUS DISPLAY	12
DISPLAY	13
SERVICE MODE	13
VMC – VENDING MACHINE CONTROLLER	14
MENU HIERARCHY	15
SERVICE MODE NAVIGATION	15
DELIVERY SYSTEM	49
PRODUCT TRAYS	49
PRICE SCROLLS AND SELECTION LABELS	49
VIGILANT VEND SENSOR SYSTEM	50
TROUBLESHOOTING	52
WIRING DIAGRAMS	56
MACHINE ASSEMBLIES	60

## SPECIFICATIONS

### Domestic (115 V)

Specifications	4-Wide	5-Wide	5-Wide
	Ambient	Ambient	Refrigerated
Height	72"	72"	72"
Width	35"	39"	39"
Depth	37"	37"	37"
Floor Space	9 Sq. Ft.	9.75 Sq. Ft.	9.75 Sq. Ft.
Packing Size		62.53 Cu. Ft.	62.53 Cu. Ft.
Voltage (AC)	115V	115V	115V
Hertz	60Hz	60Hz	60Hz
Running Amperes	0.5 Amp	0.5 Amp	3.3 Amp
Watts	60 Watts	60 Watts	380 Watts
Refrigerant Type		-	R290
Refrigerant Charge		-	2.65 oz

### International (230 V)

Specifications	4-Wide		5-Wide	
	Ambient	Refrigerated	Ambient	Refrigerated
Height	184 cm	184 cm	184 cm	184 cm
Width	89 cm	89 cm	99 cm	99 cm
Depth	93 cm	93 cm	93 cm	93 cm
Floor Space	0.81 S Mtr	0.81 S Mtr	0.90 S Mtr	0.90 S Mtr
Packing Size		1.59 Cu Mtr	1.77 Cu Mtr	1.77 Cu Mtr
Voltage (AC)	230V	230V	230V	230V
Hertz	60Hz	50Hz	60Hz	60Hz
Running Amperes	0.3 Amp	1.65 Amp	0.3 Amp	1.65 Amp
Watts	58 Watts	190 Watts	58 Watts	190 Watts
Refrigerant Type	-	R290	-	R290
Refrigerant Charge	-	2.65 oz	-	2.65 oz

**PHYSICAL CHARACTERISTICS**

- Finish: Powder Coat paint
- Compliant with US ADA standards for vending equipment.

**ENVIRONMENT**

- Indoor only

**ELECTRICAL REQUIREMENT**

Domestic versions require (1) 115 VAC 12 Amps grounded outlet International versions require (1) 230 VAC 12 Amps grounded outlet

**STANDARD COIL CONFIGURATION**

Custom configurations available.

Our standard configuration is subject to change without notice to keep up with market and location demand for new products.

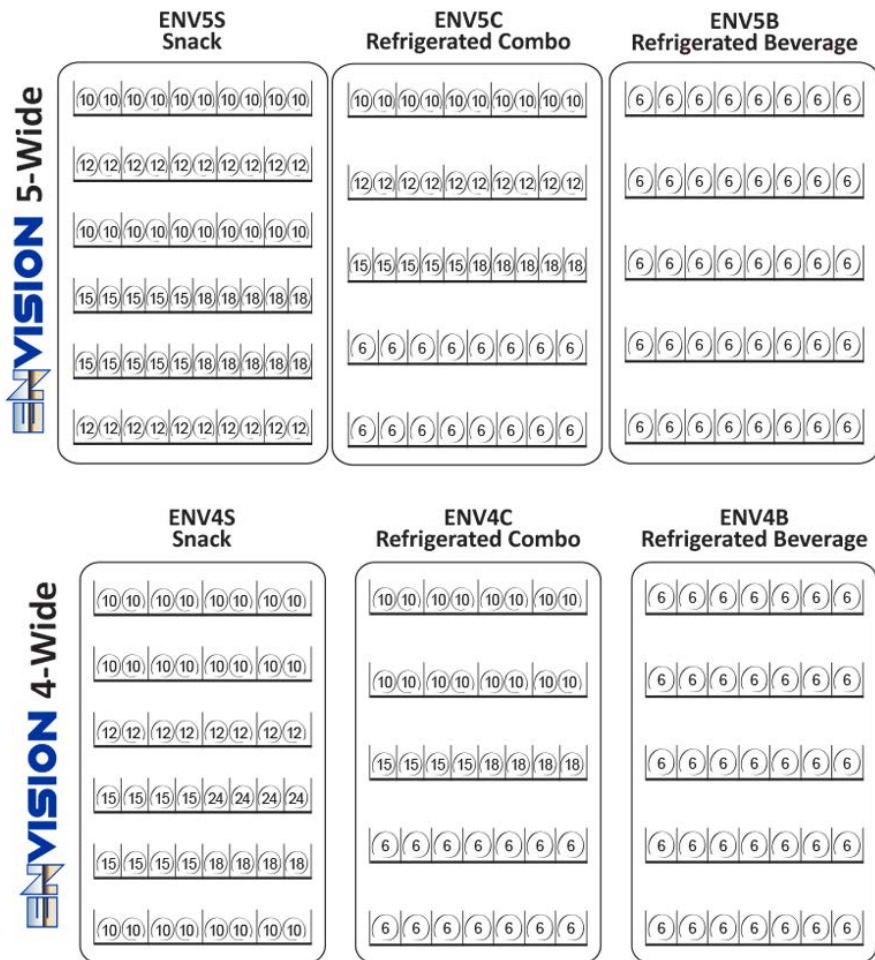

*Not all models available in all countries.*

**CAUTION:** Certain procedures described in this manual require electrical power to the vending machine. Only trained personnel should perform these functions. Use extreme caution while performing the procedures marked with the voltage symbol shown here:



**CAUTION:** Certain procedures described in this manual require a qualified, trained technician to perform the particular task at hand. These procedures will be marked with the attention symbol shown here:



Fig. 1 – Exterior View



Your EnVision vending machine arrives with a special protected skid that prevents damage to the door due to improper lifting. When installing the machine on location, the Door Protectors and Skid Feet must be removed. A Phillips head screwdriver is required.

Fig. 2 – Door Protectors and Skid Feet



1.) Remove Front and Back Door Protectors by removing four screws (2 front, 2 back) from the skid feet. (Fig. 2a)

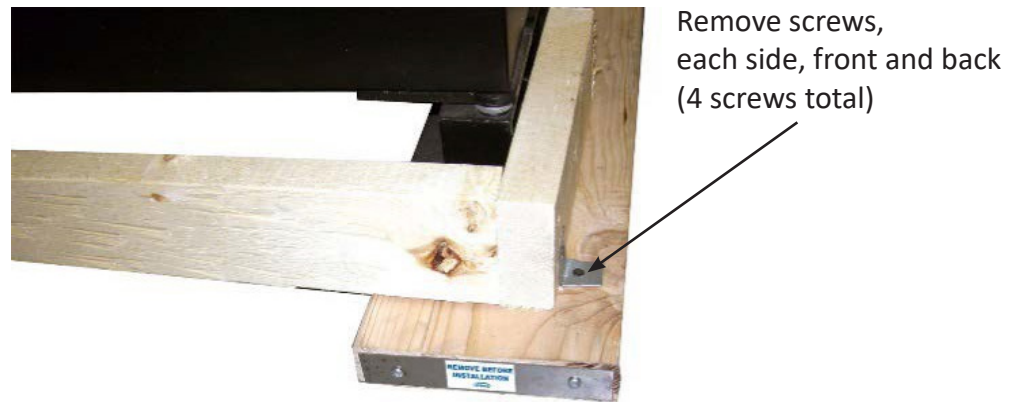

2.) On each side of the vending machine, remove four (4) screws from the front and back of the skid feet, remove plates. The boards will then come apart and off the leg levelers. (Fig. 2b)

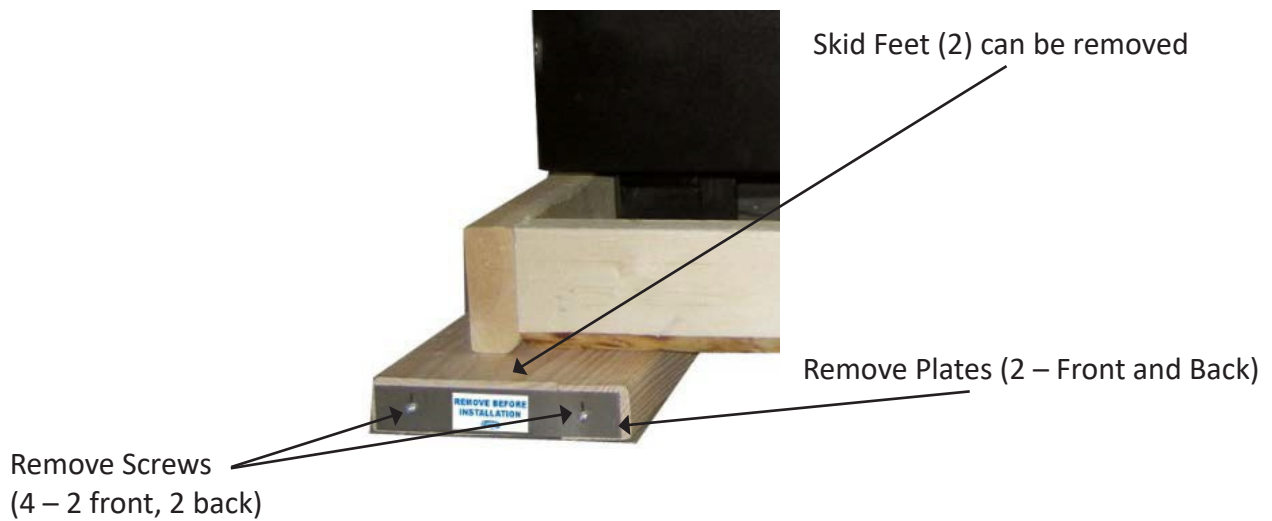

Proper leveling is also necessary to allow easy opening and closure of the vending machine door and to insure proper vending operation.

Fig. 3 - Leg Levelers

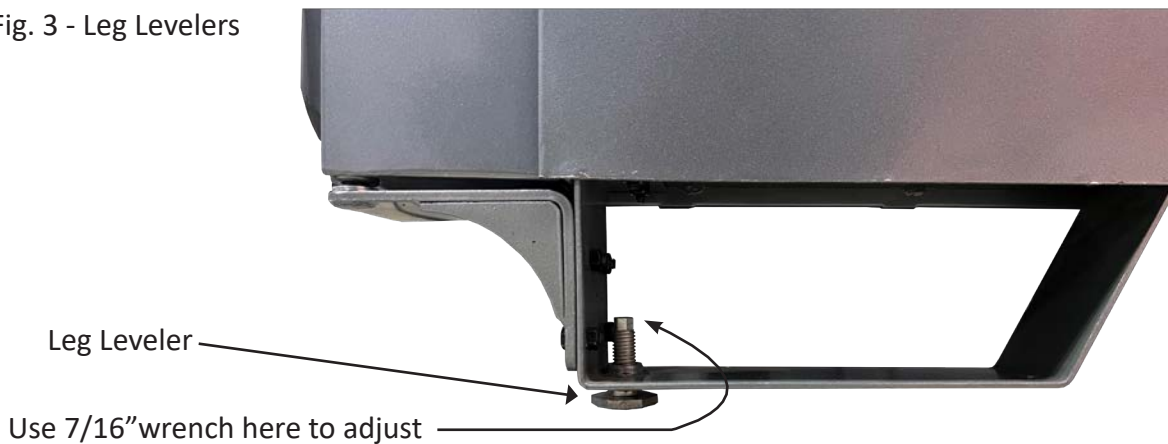

Fig. 4 - Interior View

Control Board

Service Mode Button



Power Switch



ENV5C/5B Refrigerated models,  
modular refrigeration deck.

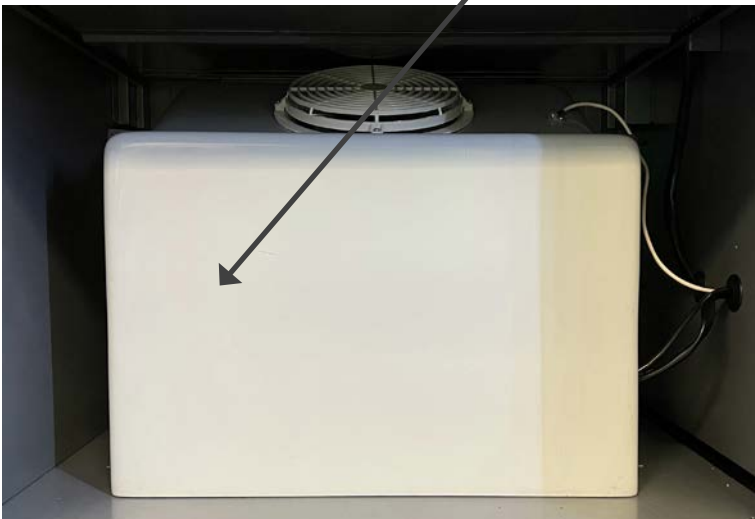



## CAUTIONS



### **Your vendor is intended for indoor use only.**

Excessive heat, cold or humidity levels will void your warranty; install only in climate controlled, indoor environments. For indoor machines the temperature range must be no higher than 32°C/90°F and no lower than 10°C/50°F with a relative humidity (Rh) level of no greater than 45%.

Your vendor must be set on a level, well-supported location. Always unload vendor before transporting it.



### **CAUTION!**

It is important that the power supplied to the vendor is the proper voltage. Verify the voltage before connecting the machine to a wall outlet.



### **CAUTION!**

Different countries may have different power arrangements. Insure that the machine is properly grounded before operating.



### **CAUTION!**

If the power cord is damaged, it must be replaced by the manufacturer, authorized service agent or a similarly qualified person to avoid electrical hazards.



### **ATTENTION!**

This vending machine is very heavy. Make certain that sufficient personnel are available for lifting or transporting the machine. Use proper lifting procedures and equipment. Do not slide more trays out than 1 at a time; machine may tip over.



### **CAUTION!**

Certain components of this machine are sensitive to static electricity. Precautions for handling sensitive devices should be observed when handling these items.



### **ATTENTION!**

Refrigerated models need air flow. Leave at least 6" between the back of the vending machine and the wall. Condenser cooling air is taken in the bottom and exhausted out the back of the machine. Clean the condenser once every two weeks or more often for dusty or dirty locations.



**DANGER!**

Risk Of Fire or Explosion. Flammable Refrigerant Used. Do Not Puncture Refrigerant Tubing. **DANGER** - RISQUE DE FEU OU D'EXPLOSION. LE FRIGORIGÈNE EST INFLAMMABLE. NE PAS UTILISER D'APPAREILS MÉCANIQUES POUR DÉGIVRER LE RÉFRIGÉRATEUR. NE PAS PERFORER LA TUBULURE CONTENANT LE FRIGORIGÈNE.



**DANGER!**

Risk Of Fire Or Explosion. Flammable Refrigerant Used. To Be Repaired Only By Trained Service Personnel. Do Not Puncture Refrigerant Tubing. **DANGER** - RISQUE DE FEU OU D'EXPLOSION. LE FRIGORIGÈNE EST INFLAMMABLE. CONFIR LES RÉPARATIONS À UN TECHNICIEN SPÉCIALISÉ. NE PAS PERFORER LA TUBULURE CONTENANT LE FRIGORIGÈNE.



**CAUTION!**

Risk Of Fire Or Explosion. Flammable Refrigerant Used. Consult Service and Repair Manual Before Attempting to Install Or Service This Product. All Safety Precautions Must Be Followed. **ATTENTION** - RISQUE D'INCENDIE OU D'EXPLOSION. RÉFRIGÉRANT INFLAMMABLE UTILISÉ. CONSULTEZ LE MANUEL D'ENTRETIEN ET DE RÉPARATION AVANT D'ESSAYER D'INSTALLER OU DE RÉPARER CE PRODUIT. TOUTES LES PRÉCAUTIONS DE SÉCURITÉ DOIVENT ÊTRE SUIVIES.



**CAUTION!**

Risk Of Fire Or Explosion. Dispose Of Properly In Accordance With Federal Or Local Regulations. Flammable Refrigerant Used. **ATTENTION** - RISQUE DE FEU OU D'EXPLOSION. ÉLIMINER CONFORMÉMENT AUX REGLEMENTS FÉDÉRAUX OU LOCAUX. LE FRIGORIGÈNE EST INFLAMMABLE.



**CAUTION!**

Risk Of Fire Or Explosion Due To Puncture Of Refrigerant Tubing; Follow Handling Instructions Carefully. Flammable Refrigerant Used. **ATTENTION** - RISQUE DE FEU OU D'EXPLOSION SI LA TUBULURE CONTENANT LE FRIGORIGÈNE EST PERFORÉE; SUIVRE LES INSTRUCTIONS DE MANUTENTION AVEC SOIN. LE FRIGORIGÈNE EST INFLAMMABLE.

## LOADING PRODUCTS

To present your product in as an attractive and professional manner as possible, do not load any damaged items, and make sure items are facing forward for easy identification by your customer. Note: The size of the item being vended must be larger than the Helix Coil, but smaller than the Product Column to vend correctly. Never force an oversized item into the Helix Coil or Product Column, nor attempt to vend an item that is smaller than the Helix Coil as this will create problems and deter customers. (Fig.5)

### 1. To Load Product:

- A.) Push down and hold the release latch located on the right side of the tray and slide the desired Product Tray toward you, all of the way forward. Product Tray will tilt down or can be removed and placed on the floor or a table. **Note: Pull out only one (1) Product Tray at a time. Beverage trays do not tilt for loading**
- B.) Place product in proper size Helix Coil. Note: Bottom of product must rest on the Product Tray and not on the Helix Coil. (Fig. 5) Load each column from front to back.
- Note:** Do not leave any spaces between items.
- C.) Once Product Tray is loaded, lift the front of the tray to level and push it back in. Repeat above steps until all Product Trays are fully loaded.
- D.) After loading the product, if you have removed the tray to do so, place the Tray in the cabinet by aligning the wheels in the guide rails. Clear the wire harness To the side so that it is not interfering with the tray below.

**Note:** We suggest that you always partially fill the vendor with product and perform at least five (5) test vends. Test vends can be performed easily by entering Service Mode and using the Diagnostics/Motors to select the selection to test.

Fig. 5 – Loading Helix Coils

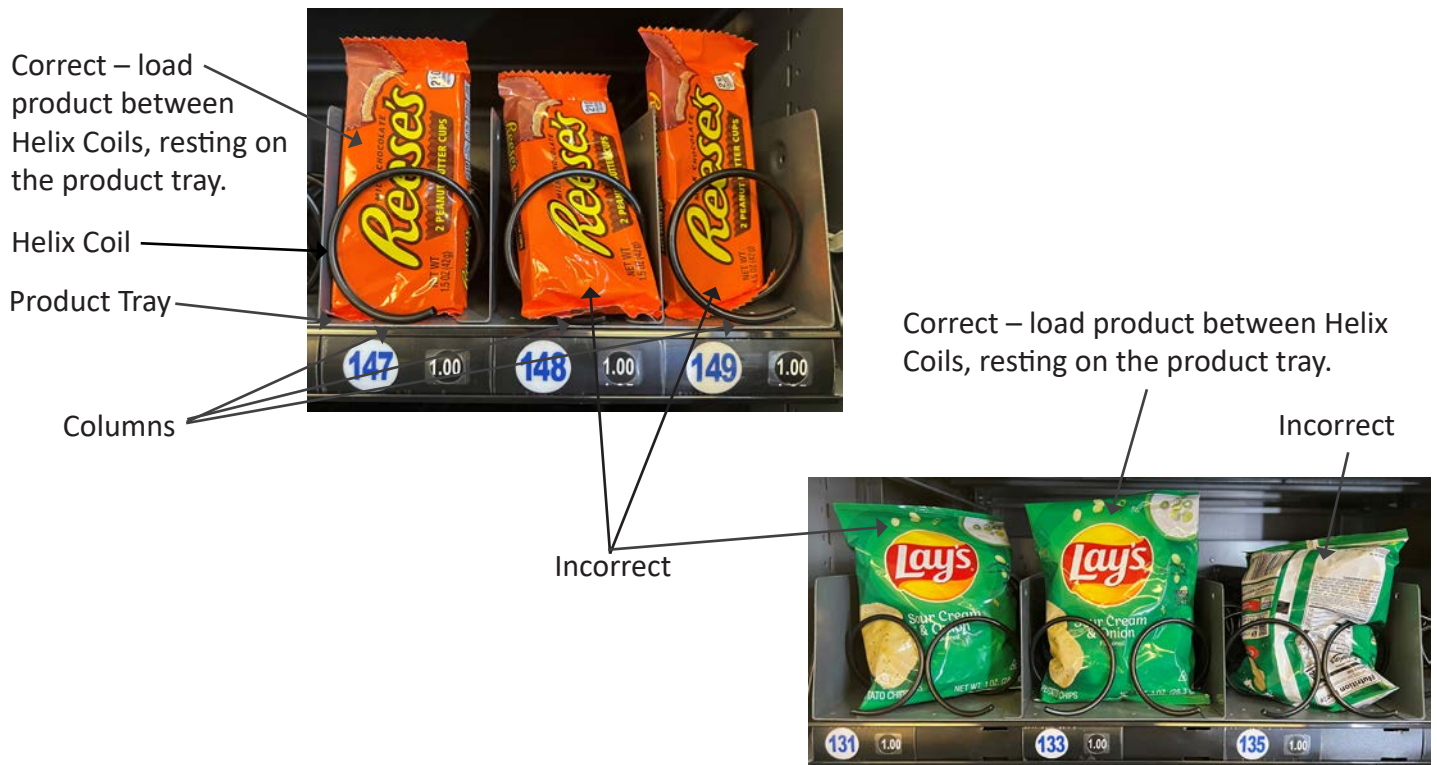

## **PRODUCT PUSHERS**

Product pushers assist in moving the top of the product forward while it is being vended on the bottom, helping it fall smoothly from the shelf. Product pushers are also good for products that have the wrapper flaps on the ends of the package.

Packaging such as this can benefit from the extra momentum that the product pushers give to keep the flaps from hanging up the product on the spiral. Product pushers are available from Seaga's Customer Care and Parts department. The pusher is installed approximately ½ inch (1.5 cm) from the end of the coil with the tab extending forward (see Fig. 6). Locate the pusher in its proper position, hold it against the coil wire and push the semi-circular part around the coil wire. Note: Boxed items will not need a product pusher.

Figure 6 – Product Pusher Installation



## **LOADING BAGGED OR BOXED ITEMS**

Vending small bagged items in the 8 or 10 selection trays can be a problem when the products are not loaded properly. The flap edges of some products may get trapped under the spiral and cause the product to “hang up”. It is recommended that the bottom flap of this type of packaging be folded forward and up (Fig. 5) next to the product when loading. This type of packaging also lets the product settle to the bottom, so using the wider spirals is also recommended.

## **LOCK**

Your vendor has one Lock, more commonly known as T-handle lock. To unlock the front door, insert key and turn clockwise ¼ turn. When unlocked the ‘T’ of the Lock will pop out from its base. Turn the ‘T’ counter clock wise to unlock the door. To lock the door, firmly close the door and turn the ‘T’ handle clockwise 1 to 2 times and then pull on the door to test that the lock has engaged. If so, then push the ‘T’ inside the Lock to lock the door and remove the key. Note: Do not over-tighten when locking – this could strip the threads and damage your machine.

## REFRIGERATION

If you purchased a refrigerated model, please see special information throughout the manual regarding refrigeration, settings and other information. The refrigeration system consists of the Compressor, Relay Circuit, Accumulator, Condenser, Condenser Fan, Evaporator, Evaporator Fan and Air Duct. The entire refrigeration system is modular and has a separate internal power cord, which is plugged into the panel provided at the lower area below the bottom tray. The power switch has to be turned ON in order to start up the refrigeration system. There is a door switch that controls the refrigeration system ON and OFF condition. When the door is opened, the door switch is not depressed and the refrigeration system shuts OFF.

When the door is closed, the switch is activated and the evaporator fan starts turning. There will be a few seconds delay before compressor starts running after the door closure.

There is a vent on the cabinet back to blow the air from condenser. The inlet vent is at the bottom of the cabinet in front of the condenser. The condenser has to be cleaned regularly. The recommended frequency is once every two weeks. The refrigeration deck cover will need to be removed, to remove it, grab each side of the cover and pull towards you. The cover is held in place with 2 grab latches, one on each side. This will provide the access to the condenser. Using a vacuum cleaner or a brush, clean the lint in between the condenser fins. **Note:** Be careful not to bend the fins – this could restrict airflow and damage your machine.

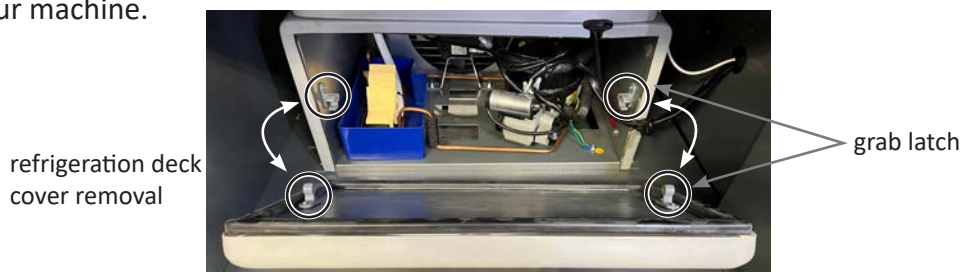

The compressor and the relay circuit, condenser fan motor and drain pan can be accessed in the same manner by removing the front cover. The refrigeration deck has to be unplugged and the module has to slide completely outside in order to gain access to these components.

**NOTE:** When moving the vending machine, care must be taken to never tilt the unit more than 20° in any direction. After moving, DO NOT plug the unit in to power so that the compressor system oils are allowed to settle. Failure to heed these instructions can cause severe damage to your vending machine and void your warranty.

## REFRIGERATION STATUS DISPLAY

Use the “#” key on the Keypad to display the following indications of the refrigeration system on the LCD Display: Figure 8 – Refrigeration Indicators on LCD Display

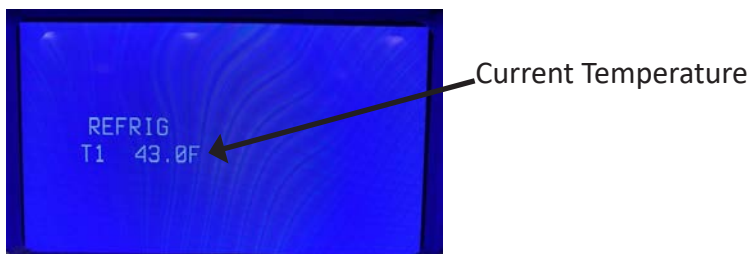

## DISPLAY

The LCD Display (Fig. 9) is a character text display panel located on the front of your vending machine. The display interacts with the customer to show the amount of money entered into the vendor and the cost of their selection among other information as programmed. The display also shows the operator the Service Mode functions for setting the vendor.

Fig. 9 – LCD Display in Sales Mode



Display Formats	When in Sales Mode Display Reads
Normal Operation, no credit available	Good Morning, Good Afternoon & Good Evening
Normal Operation, some credit available	\$00.01 – 99.99
After Pressing a selection, if there is no credit or the credit is less than the selection's price, the price of the selection is displayed for a few seconds before reverting to one of the above credit display formats. (If a coin or other payment is made the display reverts immediately to display the credit available)	Price \$00.01 – 99.99
Free Vend Mode (all prices set to zero)	Free Vend
If a selection is out of stock when a selection is pressed – this is displayed for a few seconds	Sold Out
All Items out of stock	Sold Out
Machine Out Of Order	Out of Order
During a Vend (Progress bar, dashes)	-----
Exact Change required	Exact Change Only
Temperature Display Press the # button to display	Temp nnF (C)

If a calorie value is set for a selection, the value will be displayed when the product is vended or when a selection is made without any credit.

## SERVICE MODE

The operation of the machine can be adjusted by entering service mode by pressing the MENU button on the VMC circuit board and then accessing the appropriate operation. Price setting, audit display and operating modes can be read and adjusted from here. The user can also perform tests on the machine through this mode. ***Note: any Credit will be cancelled on entry to Service Mode.***

## VMC – VENDING MACHINE CONTROLLER

Enter Service Mode by pressing the MENU Button on the VMC Circuit board. (Fig. 11)

Figure 11 – VMC and Menu Button

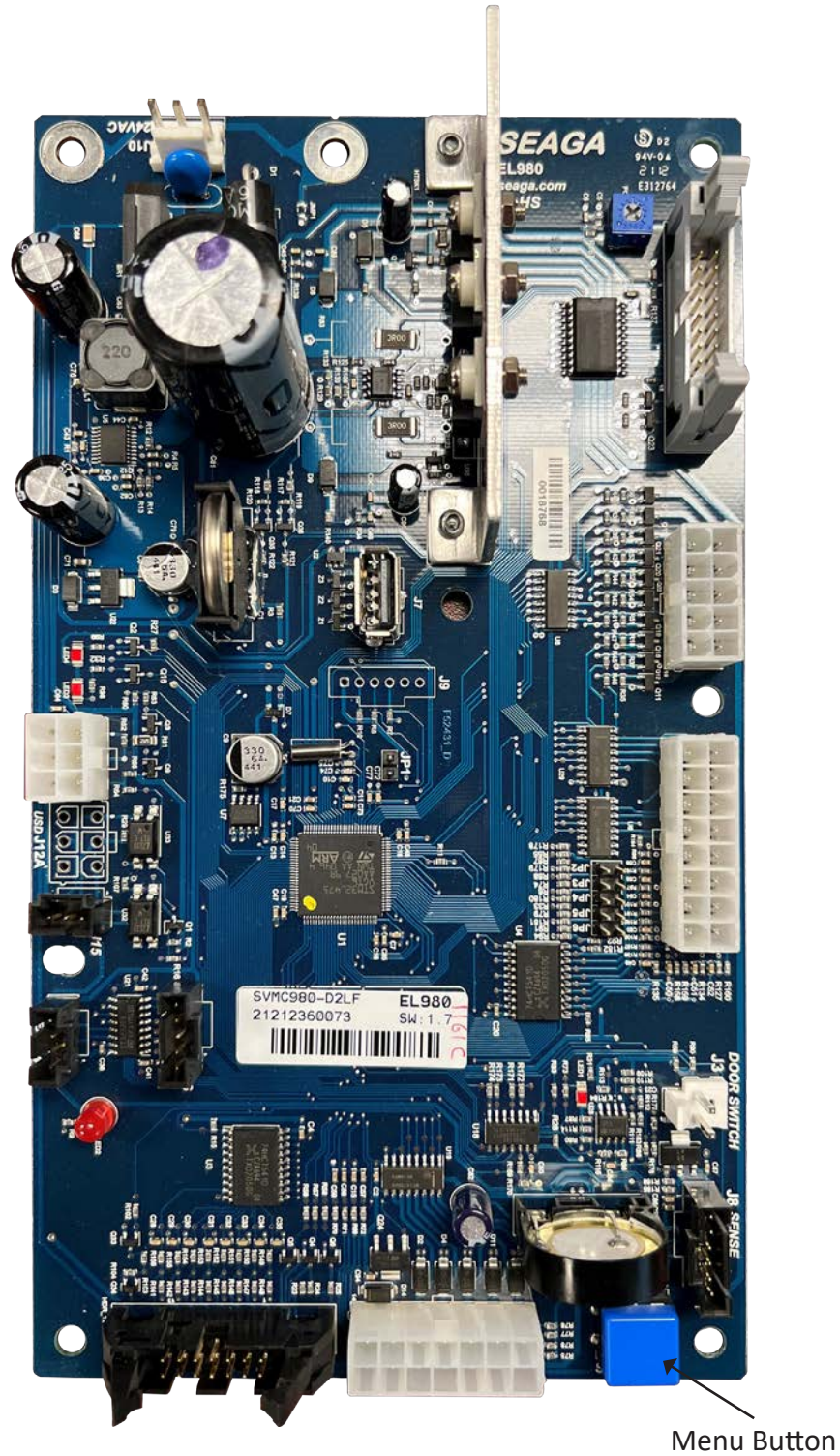

## SERVICE MODE NAVIGATION

Use the 0 through 9 keys to access the various menus and sub-menus.

Use the " " key on the keypad to Exit without changing or to go back (Previous).

1	2	3
4	5	6
7	8	9
	0	#

\* = Exit or Next

# = Save

### MENU HIERARCHY

<b>1</b> PRICE PROG	<b>2</b> CASH COUNT	<b>3</b> COIN PAYOUT	<b>4</b> CONFIGURATION	<b>5</b> OPTIONS
All Items Row Selection Coupon Token Combo Calories Lottery	All Items Row Selection Short DEX Reset on Read	Enter this mode when priming/ filling the changer	Date/Time Health Safety Language All Items – Type Row – Type Selection – Type Auto Reinstate Space to Sales (StS) StS Custom  Advanced (pw) Beep Enable Optics Disable Motor type Temp Selection Style Touch Comm	Forced Vend Bill Escrow Multi-Vend Free Vend Fast Change Optical Vend POS Message Set Point Drop Sensor
<b>6</b> ADVANCED	<b>7</b> MOTORS	<b>8</b> SELECTION	<b>9</b> ELECTION: ALL	<b>0</b> TEST MODES
Discount Exact Change Unconditional Acceptance Max Change Shutdown Energy Savings Pair	Enter this mode to verify motor count after changing selections or trays or as a test to verify all motors are operating	Enter this mode to perform a single test vend on a selection of your choice	Enter this mode to perform a loop style test vend on all selections USE <b>ONLY WHEN COILS          ARE EMPTY!</b> To stop the loop test, press *	Relays Vend Sensor Drop Bias Setting* Do not use System Logs* Do not use On Door Manual Defrost



## **1. PRICE PROGRAM**

Price Program is used to set the prices for All Items, by Row or by individual Selection. Save time and set All Items to the most common price, going back to Row or Selection for different prices as required.

### **ALL ITEMS**

1. Press service mode button
2. Press 1 for price program
3. Press 1 for all items
4. Use number keys to enter new price
5. Press # to save changes
6. Press  to exit to previous menu

### **ROW**

1. Press Service Mode Button
2. Press 1 for Price Program
3. Press 2 for Row
4. Use number keys to enter Row number
5. Use number keys to set new price, including cents.
6. Press # to Save changes
7. Press # to go to Next row or
8. Press  to exit to previous menu





### **SELECTION**

1. Press Service Mode Button
2. Press 1 for Price Program
3. Press 3 for Selection
4. Use number keys to enter Selection number
5. Use number keys to set new price, including cents.
6. Press # to Save changes
7. Press # to go to Next selection or
8. Press  to exit to previous menu





### **COUPON**

**IMPORTANT:** This option requires a programmed validator. Up to five different coupon values can be set. In sales mode, once a coupon is accepted, no further coupons will be accepted until a successful vend has been made. If no value is set, coupons will be shown as free vends. If using both coupons and tokens, there are only five selection combinations available. For example, if Coupon1 is set for "All Items", Token1 is also set for "All Items".

## COUPONS ALL ITEMS





1. Press Service Mode Button
2. Press 1 for Price Program
3. Press 4 for Coupons
4. Press 1 for Coupon1 (or corresponding number for additional coupons, up to Coupon5)
5. Press 1 for All Items
6. Press 1 to toggle On/Off
7. Press # to Save changes
8. Press  to Exit to previous menu
9. Press 4 to enter Coupon1 Value menu
10. Use number keys to enter Coupon1 value
11. Press # to save changes, or  to delete Coupon value then # to Save
12. Press  to exit to previous menu
13. Select Coupon2 – 5 to continue or Press  to exit to previous menu

## COUPON BY ROW

1. Press Service Mode Button
2. Press 1 for Price Program
3. Press 4 for Coupons
4. Press 1 for Coupon1 (or corresponding number for additional coupons, up to Coupon5)
5. Press 1 for All Items
6. Press 1 to toggle to Off
7. Press # to save changes
8. Press  to exit to previous menu
9. Press 2 to enter a Row Number
10. Use number keys to enter Row Number
11. Press 1 to toggle Row On/Off
12. Press # to save the setting
13. Press  to exit to previous menu
14. Press 4 to enter Coupon Value menu
15. Use the number keys to enter Coupon1 value
16. Press # to save changes, or  to delete Coupon value then # to Save
17. Press  to exit to previous menu
18. Select Coupon2 – 5 to continue or Press  to exit to previous menu

## COUPON BY SELECTION





1. Press Service Mode Button
2. Press 1 for Price Program
3. Press 4 for Coupons
4. Press 1 for Coupon1 (or corresponding number for additional coupons, up to Coupon5)
5. Press 1 for All Items
6. Press 1 to toggle to Off
7. Press # to save changes
8. Press  to exit to previous menu
9. Press 3 to enter a Selection
10. Use the number keys to enter a Selection number

11. Press 1 to toggle Item On/Off
12. Press # to save the setting
13. Press  to exit to previous menu
14. Press 4 to enter Coupon Value menu
15. Press # to edit Coupon1 value
16. Use the number keys to enter Coupon1 value
17. Press # to save changes, or  to delete Coupon value then # to Save
18. Press  to exit to previous menu
19. Select Coupon2 – 5 to continue or Press  to exit to previous menu



## TOKEN

IMPORTANT: This option requires a programmed changer and allows you to set the value of tokens accepted.  
 Note: If Space to Sales Whole Machine is On and you are setting Tokens by Row, the Row must be set to Row 1.  
 If using both coupons and tokens, there are only five selection combinations available. For example, if Coupon1 is set for “All Items”, Token1 is also set for “All Items”.





### TOKEN ALL ITEMS

1. Press Service Mode Button
2. Press 1 for Price Program
3. Press 5 for Tokens
4. Press 1 for Token1 (or corresponding number for additional tokens, up to Token5)
5. Press 1 for All Items
6. Press 1 to toggle On/Off
7. Press # to save changes
8. Press  to exit to previous menu
9. Press 4 to enter Token Value menu
10. Use number keys to enter Token1 value
11. Press # to save changes, or  to delete Coupon value then # to Save
12. Press  to exit to previous menu
13. Select Token2 – 5 to continue or press  to exit to previous menu

### TOKEN BY ROW

1. Press Service Mode Button
2. Press 1 for Price Program
3. Press 5 for Tokens
4. Press 1 for Token1 (or corresponding number for additional coupons, up to Token5)
5. Press 1 for All Items
6. Press 1 to toggle to Off
7. Press # to save changes
8. Press  to exit to previous menu
9. Press 2 to enter a Row Number
10. Use number keys to enter Row Number
11. Press 1 to toggle Row On/Off
12. Press # to save the setting
13. Press  to exit to previous menu
14. Select Token2 – 5 to continue or Press  to exit to previous menu

## TOKEN BY SELECTION

1. Press Service Mode Button
2. Press 1 for Price Program
3. Press 5 for Tokens
4. Press 1 for Token1 (or corresponding number for additional coupons, up to Token5)
5. Press 1 for All Items
6. Press 1 to toggle to Off
7. Press # to save changes
8. Press  to exit to previous menu
9. Press 3 to enter a Selection Number
10. Use number keys to enter Selection Number
11. Press 1 to toggle Selection On/Off
12. Press # to save changes
13. Press  to exit to previous menu
14. Press 4 to enter Token Value menu
15. Use number keys to enter Token value
16. Press # to save changes, or "" to delete Coupon value then # to Save
17. Press  to exit to previous menu
18. Select Token2 – 5 to continue or Press  to exit to previous menu



## COMBO

1. Press Service Mode Button
2. Press 1 for Price Program
3. Press 6 for Combo menu
4. Press 1 for Combo1 (or corresponding number for additional combos, up to 10 options available)
5. Press # to edit
6. Use number keys to enter First Combo Item Number
7. Press # to Save changes
8. Use number keys to enter First Combo Item Price
9. Press # to save changes
10. Press 1 (next) to enter the Selection Ranges
11. Enter Range number, then enter selection numbers

Note: A Range represents the first selection(s) in the combo. In our example, the range would be selection 110 to 110. A second range would be set for selection 131 to 131 and the third range for 142 to 142. This would complete the three item Combo.

12. Press 1 to advance to the next Range.
13. To continue setting Ranges, repeat steps 10 and 11. There are 5 ranges available per combo.
14. When finished press  to exit to previous menu

\*\*\*To delete a previously set Combo\*\*\*

1. Press Service Mode Button
2. Press 1 for Price Program
3. Press 6 for Combo menu
4. Press 1 for Combo1 menu (or corresponding number for additional combos, up to 10 options available)
5. Press # to edit the Combo
6. Press  to delete the selection number
7. Press # to changes
8. Press  to exit to previous menu
9. Repeat steps 4-8 for other Combos

## **CALORIES**

### **CALORIES ALL ITEMS**

1. Press Service Mode Button
2. Press 1 for Price Program
3. Press 7 for Calories
4. Press 1 All Items
5. Using number keys enter Calorie Value
6. Press # to save changes
7. Press  to exit to previous menu



### **CALORIES BY ROW**

1. Press Service Mode Button
2. Press 1 for Price Program
3. Press 7 for Calories
4. Press 2 Row
5. Use number keys to enter Row Number
6. Use number keys to enter Calorie Value
7. Press # to Save Changes
8. Press # for Next Row
9. Repeat Steps 5-8 until finished
10. Press  to exit to previous menu

### **CALORIES BY SELECTION**

1. Press Service Mode Button
2. Press 1 for Price Program
3. Press 7 for Calories
4. Press 3 Selection
5. Use number keys to enter Selection Number
6. Use number keys to enter Calorie Value
7. Press # to Save Changes
8. Press # for Next Selection
9. Repeat Steps 5-8 until finished
10. Press  to exit to previous menu

## LOTTERY

1. Press Service Mode Button
2. Press 1 for Price Program
3. Press 8 for Lottery
4. Press 1 for Lottery Rate
5. Press # to edit
6. Use number keys to enter number of vends
7. Press # to Save Changes
8. Press  to exit to previous menu
9. Press 2 for Lottery Enable
10. Press 2 to toggle between ON/OFF
11. Press # to Save Changes
12. Press  to exit to previous menu

## 2. CASH COUNTERS

Cash Counters displays the total vend count and the total sales value for the machine, for All Items, by Row or by individual Selection. Note: The resettable counters can be cleared.

### ALL ITEMS (1)

1. Press Service Mode Button
2. Press 2 for Cash Counters
3. Press 1 for All Items
4. Press 1 to view Historical Count
5. Press 2 to view Historical Cash
6. Press 3 to Reset Count
7. Press 4 to Reset Cash
8. Press 5 to view Historical Card
9. Press 6 to Reset Card
10. Press 7 to Clear
11. Press  to exit to previous menu

### ROW (2)

1. Press Service Mode Button
2. Press 2 for Cash Counters
3. Press 2 for Row
4. Use number keys to enter Row number
5. Press 1 to view Historical Count
6. Press 2 to view Historical Cash
7. Press 3 to Reset Count
8. Press 4 to Reset Cash
9. Press 5 to view Historical Card
10. Press 6 to Reset Card
11. Press  to exit to previous menu

### **SELECTION (3)**

1. Press Service Mode Button
2. Press 2 for Cash Counters
3. Press 3 for Selection
4. Use number keys to enter Selection number
5. Press 1 to view Historical Count
6. Press 2 to view Historical Cash
7. Press 3 to Reset Count
8. Press 4 to Reset Cash
9. Press 5 to view Historical Card
10. Press 6 to Reset Card
11. Press  to exit to previous menu

### **SHORT DEX (4)**

1. Press Service Mode Button
2. Press 2 for Cash Counters
3. Press 4 for Short Dex
4. Press 4 to toggle On/Off
5. Press # to Save changes
6. Press  to exit to previous menu

### **RESET ON READ (5)**

1. Press Service Mode Button
2. Press 2 for Cash Counters
3. Press 5 for Reset on Read
4. Press 5 to toggle On/Off
5. Press # to Save changes
6. Press  to exit to previous menu

### **3. COIN PAYOUT**



Enter this menu when priming the changer with coins. As you load coins from the front door in the coin slot, this menu will keep track of the quantity and monetary amount which enables the VMC to know that change can be made during sales transactions.

### **4. CONFIGURATION**





The following sub-menus are included in the Configuration Menu:

- Date/Time
- Health Safety
- Language
- All Items – Type
- Row – Type
- Selection – Type
- Auto Reinstate
- StS
- StS Custom
- Advanced Config\*



## DATE/TIME

1. Press Service Mode Button
2. Press 4 for Configuration
3. Press 1 for Date/Time
4. Press 1 to change Date (MM/DD/YY)
5. Press # to Edit Date
6. Use number keys to enter Date in format shown
7. Press # to Save changes
8. Press  to exit to previous menu
9. Press 2 to change Time (HH:MM:SS) AM/PM
10. Press # to Edit Time
11. Use number keys to enter Time in format shown
12. Press # to Save changes
13. Press  to exit to previous menu
14. Press 3 to change DST (Daylight Savings Time)
15. Press 3 to toggle between OFF, Australia, Europe, or North America
16. Press # to Save changes
17. Press  to exit to previous menu

## HEALTH SAFETY

1. Press Service Mode Button
2. Press 4 for Configuration
3. Press 2 for Health Safety
4. Press 1 to change Upper Zone
5. Press 1 to change All Items
6. Press 1 to toggle On/Off to set preferences
7. Press # to Save changes
8. Press  to exit to previous menu
9. Press 2 to change Row
10. Use number keys to enter Row number
11. Press 1 to toggle On/Off to set preferences
12. Press # to Save changes
13. Press  to exit to previous menu
14. Press 3 to change one Selection
15. Use number keys to enter Selection number
16. Press 1 to toggle On/Off to set preferences
17. Press # to Save changes
18. Press  to exit to previous menu
19. Press 2 to change Lower Zone
20. Press 1 to change All Items
21. Press 1 to toggle On/Off to set preferences
22. Press # to Save changes
23. Press  to exit to previous menu
24. Press 2 to change Row
25. Use number keys to enter Row number
26. Press 1 to toggle On/Off to set preferences



27. Press # to Save changes
28. Press  to exit to previous menu
29. Press 3 to change one Selection
30. Use number keys to enter Selection number
31. Press 1 to toggle On/Off to set preferences
32. Press # to Save changes
33. Press  to exit to previous menu
34. Press 9 to change Autoreinstate status
35. Press 9 to toggle between On/Off to execute preferences
36. Press # to Save changes
37. Press  to exit to previous menu

## LANGUAGE

1. Press Service Mode Button
2. Press 4 for Configuration
3. Press 3 for Language
4. Press 3 to toggle between English, Spanish or French
5. Press # to Save changes
6. Press  to exit to previous menu

## ALL ITEMS: TYPE

1. Press Service Mode Button
2. Press 4 for Configuration
3. Press 4 for All Items: Type\*
4. Press 1 to Edit/Toggle between Snack, Can or SO Switch
5. Press # to Save changes
6. Press  to exit to previous menu

## ROW: TYPE

1. Press Service Mode Button
2. Press 4 for Configuration
3. Press 5 for Row: Type\*
4. Use number keys to enter Row number
5. Press 1 to Edit/Toggle between Snack, Can or SO Switch
6. Press # to Save changes
7. Press  to exit to previous menu

*NOTE: This should ALWAYS be set on Snack; setting to other Types will cause vend sensor failure.
---

## SELECTION: TYPE





1. Press Service Mode Button
2. Press 4 for Configuration
3. Press 6 for Selection: Type\*
4. Use number keys to enter Selection number
5. Press 1 to Edit/Toggle between Snack, Can or SO Switch
6. Press # to Save changes
7. Press  to exit to previous menu

*NOTE: This should ALWAYS be set on Snack; setting to other Types will cause vend sensor failure.
---

## AUTOREINSTATE

This feature reinstates a selection after a vend failure, per the Vigilant Vend Sensor system. Normally, when an empty selection is detected during an attempted vend, that selection is recorded as inoperative and requires resetting before it can be vended again.

Note: AutoReinstate affects both the host machine and all attached satellites.

1. Press Service Mode Button
2. Press 4 for Configuration
3. Press 7 for AutoReinstate
4. Press 1 to change All Items
5. Press 1 to toggle between On/Off to set preferences
6. Press # to Save changes
7. Press  to exit to previous menu
8. Press 2 to change Row
9. Use number keys to enter Row number
10. Press 1 to toggle between On/Off to set preferences
11. Press # to Save changes
12. Press  to exit to previous menu
13. Press 3 to change one Selection
14. Use number keys to enter Selection number
15. Press 1 to toggle between On/Off to set preferences
16. Press # to Save changes
17. Press  to exit to previous menu
18. Press 9 to change Autoreinstate status
19. Press 9 to toggle between On/Off to execute preferences
20. Press # to Save changes
21. Press  to exit to previous menu

## SPACE TO SALES (STS)

Space to Sales (or StS) is a feature that rotates products so that First In First Out (FIFO) is assured and a popular item isn't sold out. This feature is only recommended for your beverage area, as the live display in the snack section would make product rotation confusing for your customer.

1. Press Service Mode Button
2. Press 4 for Configuration
3. Press 8 for Space to Sales (StS)
4. Press 8 to Edit
5. Press 8 to toggle through options:
  - StS Off
  - Whole Rows - automatically links entire rows to StS
  - Half Rows - automatically links each half of a row to StS
  - By 2's - automatically links each even/odd pairing to StS
  - Whole Machine - sets entire machine to StS
  - Custom (See next menu item)

Note: These options link everything in the machine depending on which choice is made. Links can be broken later in the Custom Space to Sales section.

6. Press # to Save changes
7. Press  to exit to previous menu

By using Space to Sales to join selections in By2's or a Row or whichever choice is made, you have insured that this popular item is dispensing from multiple selections evenly and have allocated more capacity to a best seller to prevent sold out status and made your location more satisfied with your service.

### **CUSTOM SPACE TO SALES (STS)**

If you have chosen a Space to Sales setting – Whole Row, Half Row, By 2's, Whole Machine, but you don't want all the selections to be linked, you must tell the vending machine which selection is under Space to Sales and which selections are to work separately.

1. Press Service Mode Button
2. Press 4 for Configuration
3. Press 8 for StS
4. Press 8 to toggle to your setting (in our example, By 2's)
5. Press # to Save changes
6. Press  to exit to previous menu
7. Press 9 to go to Custom Space to Sales
8. Use number keys to Enter Selection (in our example, 150)
9. Press 1 to clear links menu
10. Press # to clear current links settings



Note: This breaks the link between 150 and 151.

11. Press # to add another selection
12. Press  to exit to previous menu

Should you want to link your own specific selections, go directly to Custom Space to Sales without setting the entire machine to one of the choices (By2's, Whole Row...etc), or go into the StS menu and set it to OFF or Custom.

If you have a popular brand of water that keeps selling out before you can restock, it may be useful to set Custom StS for two selections to work in tandem, make more sales by having fresh product readily available in a larger capacity.

As an example, loading 16 oz. bottled water in selections 150 and 151.

1. Press Service Mode Button
2. Press 4 for Configuration
3. Press 8 for StS
4. Press 8 to toggle to setting Custom or OFF
5. Press # to Save changes
6. Press  to exit to previous menu
7. Press 9 to go to Custom Space to Sales (StS menu will change to Custom automatically)
8. Use number keys to Enter Selection (in our example, 150)
9. Press # to add a link
10. Use number keys to enter another selection
11. Press # to save changes
12. Press # to add another selection repeat steps 10 thru 12 until all desired links are made
13. Press  to exit to previous menu

Now, both 150 and 151 are linked as 150 but the machine will deliver product from one then the other to provide equal distribution.

## ADVANCED\*

A password is required to enter this menu. The factory default password is 2314. The following sub-menus are available under this sub-menu:

- Beep Enable
- Optics Disables
- Motor Type
- Temp
- Selection Style
- Aux Menu
- Defrost Menu
- Locker Light
- Aux USD
- Alt Card Rules

### BEEP ENABLE

1. Press Service Mode Button
2. Press 4 for Configuration
3. Press 0 for Advanced Config
4. Use number keys to enter Password (2314)
5. Press 1 for Beep Enable menu
6. Press 1 to toggle ON/OFF
7. Press # to save changes
8. Press  to exit to previous menu

### OPTICS DISABLES

1. Press Service Mode Button
2. Press 4 for Configuration
3. Press 0 for Advanced Config
4. Use number keys to enter Password (2314)
5. Press 2 for Optics Disables menu
6. Press 2 to toggle ON/OFF
7. Press # to save changes
8. Press  to exit to previous menu

### MOTOR TYPE

1. Press Service Mode Button
2. Press 4 for Configuration
3. Press 0 for Advanced Config
4. Use number keys to enter Password (2314)
5. Press 3 for Motor Type menu
6. Press 3 to toggle 3-Wire, Solenoid, 2-Wire, 2-Wire 1ms or 3-Wire Slow
7. Press # to save changes
8. Press  to exit to previous menu



## TEMP

1. Press Service Mode Button
2. Press 4 for Configuration
3. Press 0 for Advanced Config
4. Use number keys to enter password (2314)
5. Press 4 for Temp menu
6. Press 4 to toggle Snack, Cold or Cold H&S
7. Press # to save changes
8. Press  to exit to previous menu

## SEL STYLE

1. Press Service Mode Button
2. Press 4 for Configuration
3. Press 0 for Advanced Config
4. Use number keys to enter password (2314)
5. Press 5 for Sel Style
6. Press 5 to toggle 3-digit, 2-Dgt 40+, 2-Dgt even, \*/# USD
7. Press # to save changes
8. Press  to exit to previous menu

## AUX MENU

1. Press Service Mode Button
2. Press 4 for Configuration
3. Press 0 for Advanced Config
4. Use number keys to enter password (2314)
5. Press 6 for Aux Menu
6. Press 1, 2 or 3 to enter the appropriate Auxiliary Machine/Type
7. Press 1, 2 or 3 (edit option corresponds with option chosen) to toggle between 3-wire and Solenoid
8. Press # to save changes
9. Press  to exit to previous menu
10. Press 4, 5 or 6 to enter the Auxiliary Machine/Lights
11. Press 4, 5 or 6 (edit option corresponds with option chosen) to toggle between Stay On and By Door
12. Press # to save changes
13. Press  to exit to previous menu

## DEFROST MENU



1. Press Service Mode Button
2. Press 4 for Configuration
3. Press 0 for Advanced Config
4. Use number keys to enter password (2314)
5. Press 7 for Defrost Menu
6. Press 1 for Def Length
7. Press 1 to increase by 1 minute until desired time is reached (1-60)
8. Press # to save changes
9. Press  to exit to previous menu
10. Press 2 for Def Time

11. Press 2 to increase by 1 hour until desired time is reached (1-12)
12. Press # to save changes
13. Press  to exit to previous menu

### **LOCKER LIGHT**

1. Press Service Mode Button
2. Press 4 for Configuration
3. Press 0 for Advanced Config
4. Use number keys to enter password (2314)
5. Press 8 for Locker Light
6. Press 8 to toggle between Stay On and By Door
7. Press # to save changes
8. Press  to exit to previous menu

### **AUX USD**

1. Press Service Mode Button
2. Press 4 for Configuration
3. Press 0 for Advanced Config
4. Use number keys to enter password (2314)
5. Press 9 for Locker Light
6. Press  to toggle between OFF, ON, VNDNO or AUXAPI
7. Press # to save changes
8. Press  to exit to previous menu

### **ALT CARD RULES**

1. Press Service Mode Button
2. Press 4 for Configuration
3. Press 0 for Advanced Config
4. Use number keys to enter password (2314)
5. Press 0 for Alt Card Rules
6. Press 0 to toggle between OFF and ON
7. Press # to save changes
8. Press  to exit to previous menu

### **OPTIONS**

The following sub-menus are included in the Options Menu:

- Forced Vend
- Bill Escrow
- Multi Vend
- Free Vend
- Fast Change
- Optical Vend
- POS Options
- Set Point
- Sensitivity Adjust

## FORCED VEND

Forces the customer to complete a purchase once they have made payment in any form. **NOTE:** If a customer chooses a Forced Vend selection and the motor fails, the customer will be allowed to escrow the credit.

1. Press Service Mode Button
2. Press 5 for Options Menu
3. Press 1 for Forced Vend Menu
4. Press 1 to toggle between ON and OFF
5. Press # to save changes
6. Press  to exit to previous menu

## BILL ESCROW

Allows the last bill accepted to be returned, provided the bill acceptor is capable of such a feature.

1. Press Service Mode Button
2. Press 5 for Options Menu
3. Press 2 for Bill Escrow Menu
4. Press 2 to toggle between ON and OFF
5. Press # to save the setting
6. Press  to exit to previous menu

## MULTI VEND

Allows the customer to purchase more than one product if enough credit has been deposited. When Multi Vend is active, any credit remaining after a vend is NOT automatically returned. The customer makes the choice to make another selection (with sufficient credit), make further payment to make another selection or press the coin return to return any remaining credit.

**NOTE:** After 5 minutes, any credit remaining will be erased by the machine. For card reader sessions, the Multi Vend feature will function only if the card reader supports multiple vend capability.

**NOTE:** If Fast Change is set to ON, it will override Multi Vend and change will be made immediately after a selection.

1. Press Service Mode Button
2. Press 5 for Options Menu
3. Press 3 for Multi Vend Menu
4. Press 3 to toggle between ON and OFF
5. Press # to save changes
6. Press  to exit to previous menu

## FREE VEND

Sets the WHOLE MACHINE to Free Vend. Every product is at no cost, no money is accepted by the machine and the display reads "FREE ON US".

1. Press Service Mode Button
2. Press 5 for Options Menu
3. Press 4 for Free Vend Menu
4. Press 4 to toggle between ON and OFF
5. Press # to save changes
6. Press  to exit to previous menu

## FAST CHANGE

Enables the vending machine to give change immediately after the customer makes a selection. If Fast Change is ON, it overrides the Multi Vend feature.

**NOTE:** If “Optical Vend” is ON, the vend price of the product displays until a product drops.

1. Press Service Mode Button
2. Press 5 for Options Menu
3. Press 5 for Fast Change Menu
4. Press 5 to toggle between ON and OFF
5. Press # to save changes
6. Press  to exit to previous menu

## OPTICAL VEND

This sub-menu provides the operator with options for designating product items or rows that are monitored for product delivery by an optical sensor. Default is ALL selections ON unless changed. Selections that are designated as Optical have an associated vend operation that differs from the normal vend operation. For 5 milliseconds at the start of a vend, the Vigilant Vend Sensor is checked for blockage.

If blocked – the normal vend cycle is used and the optical sensors are ignored. Both the vend motor and a 10-second timeout timer are started.

- The motor rotates to the home-switch position.
- If there is a home-switch signal, the vend is considered successful.
- If there is no home-switch signal after 10 seconds, the vend motor is shut down and MAKE ANOTHER SELECTION is shown on the display.
- The customer can then make another selection or press coin return.

**NOTE:** Forced Vend is overridden if Optical Vend is set.

If not blocked, the Vigilant vend sensor system is used. Both the vend motor and a 10-second timeout timer are started.



- The selection motor rotates to the home-switch position.
- If a product is detected, the vend is considered successful.
- If, after reaching the home-switch position, a product has not been detected, the vend motor will pause for 1 second while the VMC continues to monitor the optical sensor for product delivery.
- If a product is detected during this pause, the vend is considered successful.
- If a product is not detected, the controller initiates a second vend cycle and a 9-second timer while continuing to monitor the optical sensor.
  - If a product is detected during this second cycle, the motor is stopped immediately. The vend is considered successful. The 2nd Vend Count is increased by one.
  - If a product is not detected before the motor reaches the home-switch position, or if a 9-second timer runs out, the vend has failed or the selection is sold out. Such a state will show MAKE ANOTHER SELECTION on the display and the amount of credit. The customer can make a selection or press coin return.





## **OPTICAL VEND ALL**

1. Press Service Mode Button
2. Press 5 for Options Menu
3. Press 6 for Optical Vend Menu
4. Press 1 for All Items Menu
5. Press 1 to toggle between ON and OFF to set preference
6. Press # to save changes
7. Press  to exit to previous menu

## **OPTICAL VEND BY ROW**

1. Press Service Mode Button
2. Press 5 for Options Menu
3. Press 6 for Optical Vend Menu
4. Press 2 to enter a Row
5. Use number keys to enter Row number
6. Press 1 to toggle between ON and OFF to set preference
7. Press # to save changes
8. Press  to exit to previous menu
9. Repeat Steps 4 through 7 until all desired rows are completed.
10. Press  to exit to previous menu

## **OPTICAL VEND BY SELECTION**







1. Press Service Mode Button
2. Press 5 for Options Menu
3. Press 6 for Optical Vend Menu
4. Press 3 to enter the Selection
5. Use number keys to enter the Item Number
6. Press 1 to toggle between ON and OFF to set preference
7. Press # to save changes
8. Press  to exit to previous menu
9. Repeat Steps 4 through 7 until all desired rows are completed.
10. Press  to exit to previous menu

## **OPTICAL VEND STATUS**

1. Press Service Mode Button
2. Press 5 for Options Menu
3. Press 6 for Optical Vend Menu
4. Press 9 to enter the Optical Vend status
6. Press 9 to toggle between ON, OFF or ONLY to execute preferences
7. Press # to save changes
8. Press  to exit to previous menu

## POINT OF SALE MESSAGE (POS)

Turns ON or OFF the default scrolling display message.







1. Press Service Mode Button
2. Press 5 for Options Menu
3. Press 7 for POS Options
4. Press 1 for POS Message
5. Press 1 to Edit/Toggle between ON/OFF
6. Press # to save changes
7. Press  to exit to previous menu
8. Press 2 for Show Opt Out
9. Press 2 to Edit/Toggle between ON/OFF
10. Press # to save changes
11. Press  to exit to previous menu
12. Press 3 for Time Display
13. Press 3 to Edit/Toggle between ON/OFF
14. Press # to save changes
15. Press  to exit to previous menu
16. Press 4 for Programmable POS
17. Press 4 to Edit/Toggle between ON/OFF
18. Press # to save changes
19. Press  to exit to previous menu
20. Press 5 for Date
21. Press 5 to Edit/Toggle between MM/DD/YYYY and DD/MM/YYYY
22. Press # to save changes
23. Press  to exit to previous menu
24. Press 6 for Time
25. Press 6 to Edit/Toggle between AM/PM and 24hr
26. Press # to save changes
27. Press  to exit to previous menu

## SET POINT

Displays the factory default Set Point temperature for each machine type. See Temp section for the specific machine refrigeration modes. Ambient snack machines without a refrigeration system will display 36°F. These temperatures may be adjusted; however, it is not advised without direction by Seaga Customer Care or an authorized technician. The optimal temperatures have been set according to NAMA specifications for optimal product safety. Before making any adjustment see Temp and Health Safety section.

1. Press Service Mode Button
2. Press 5 for Options Menu
3. Press 8 for Set Point
4. Press 8 to edit the temperature Set Point
5. Continue pressing 8 until the desired temperature is shown on the display
6. Press # to save changes
7. Press  to exit to previous menu

## SENSITIVITY ADJUST

1. Press Service Mode Button
2. Press 5 for Options Menu
3. Press 9 for Sensitivity Adjust
4. Press 1 for All Items
5. Press 1 to toggle through Low, Mid or High
6. Press # to save changes
7. Press  to exit to previous menu
8. Press 2 for Row
9. Use keypad to select Row number
10. Press 2 to toggle through Low, Mid or High
11. Press # to save changes
12. Press  to exit to previous menu
13. Press 4 for Sensor Edit
14. Press 4 to toggle through Low, Mid or High
15. Press # to save changes
16. Press  to exit to previous menu
17. Press 7 for Shock Trans
18. Press 7 to toggle through 0-19
19. Press # to save changes
20. Press  to exit to previous menu
21. Press 8 for Shock Period
23. Press 8 to toggle through 0-19
24. Press # to save changes
25. Press  to exit to previous menu
26. Press 9 to edit the Shock Offset sensitivity level
27. Continue pressing 9 until the desired setting is shown on the display (0-29)
28. Press # to save changes
29. Press  to exit to previous menu

## 6. ADVANCED\*







This menu requires a password. The factory default password is 2314. The following sub-menus are included in the Advanced Features menu:

- Discount
- Exact Change
- Unconditional Acceptance
- Max Change
- Currency
- Shutdown
- Energy Savings
- Paired Motors
- Degrees

## DISCOUNT ALL ITEMS





This menu uses various sub-menu settings to allow a different price for selections at different times or on different days. Only one discounted price can be set for each item, whether by All Items, Row or Selection but various time intervals can be applied.



1. Press Service Mode Button
2. Press 6 for Advanced Menu

3. Use number keys to enter Password (2314)
4. Press 1 for Discount
5. Press 1 for All Items
6. Use keypad to enter discount price for All Items
7. Press # to save changes
8. Press  to exit to previous menu
9. Press 4 for Interval1 (up to 4 Intervals may be chosen)
10. Press 1 for All Items
11. Press 1 to toggle ON/OFF
12. Press # to save changes
13. Press  to exit to previous menu
14. Press 4 for Day menu
15. Press 1 for All Days
16. Press 1 to toggle All Days ON/OFF
17. Press # to save changes
18. Press  to exit to previous menu
19. Press 2 for Monday menu
20. Repeat steps 16-18 as needed using 2 to toggle
21. Press 3 for Tuesday menu
22. Repeat steps 16-18 as needed using 3 to toggle
23. Press 4 for Wednesday menu
24. Repeat steps 16-18 as needed using 4 to toggle
25. Press 5 for Thursday menu
26. Repeat steps 16-18 as needed using 5 to toggle
27. Press 6 for Friday menu
28. Repeat steps 16-18 as needed using 6 to toggle
29. Press 7 for Saturday menu
30. Repeat steps 16-18 as needed using 7 to toggle
31. Press 8 for Sunday menu
32. Repeat steps 16-18 as needed using 8 to toggle
33. Press  to exit to previous menu
34. Press 5 for Start Time menu
35. Press # to edit
36. Use number keys to enter Start Time in 12-hr time format (HH:MM:SS) AM/PM
37. Press # to save changes
38. Press  to exit to previous menu
39. Press 6 for Stop Time menu
40. Press # to edit
41. Use number keys to enter Stop Time in 12-hr time format (HH:MM:SS) AM/PM
42. Press # to save changes
43. Press  to exit to previous menu
44. Press 7 for Enable Discount menu
45. Press 7 to toggle Enable ON/OFF
46. Press # to save changes
47. Press  to exit to previous menu

## DISCOUNT BY ROW





**NOTE:** Make sure the All Items setting in the Discount Interval menu is set to OFF. See Discount All Items.



1. Press Service Mode Button
2. Press 6 for Advanced Menu
3. Use number keys to enter Password (2314)
4. Press 1 for Discount
5. Press 2 for Row
6. Use keypad to enter Row number and discount price for the entire row
7. Press # to save changes
8. Press  to exit to previous menu
9. Press 4 for Interval1 (up to 4 Intervals may be chosen)
10. Press 2 for Row
11. Use number keys to enter row number
12. Press 1 to toggle ON/OFF
13. Press # to save changes
14. Press  to exit to previous menu
15. Press 4 for Day menu
16. Press 1 for All Days
17. Press 1 to toggle All Days ON/OFF
18. Press # to save changes
19. Press  to exit to previous menu
20. Press 2 for Monday menu
21. Repeat steps 17-19 as needed using 2 to toggle
22. Press 3 for Tuesday menu
23. Repeat steps 17-19 as needed using 3 to toggle
24. Press 4 for Wednesday menu
25. Repeat steps 17-19 as needed using 4 to toggle
26. Press 5 for Thursday menu
27. Repeat steps 17-19 as needed using 5 to toggle
28. Press 6 for Friday menu
29. Repeat steps 17-19 as needed using 6 to toggle
30. Press 7 for Saturday menu
31. Repeat steps 17-19 as needed using 7 to toggle
32. Press 8 for Sunday menu
33. Repeat steps 17-19 as needed using 8 to toggle
34. Press  to exit to previous menu
35. Press 5 for Start Time menu
36. Press # to edit
37. Use number keys to enter Start Time in 12-hr time format (HH:MM:SS) AM/PM
38. Press # to save changes
39. Press  to exit to previous menu
40. Press 6 for Stop Time menu
41. Press # to edit
42. Use number keys to enter Stop Time in 12-hr time format (HH:MM:SS) AM/PM
43. Press # to save changes

44. Press  to exit to previous menu
45. Press 7 for Enable Discount menu
46. Press 7 to toggle Enable ON/OFF
47. Press # to save changes
48. Press  to exit to previous menu

## DISCOUNT BY SELECTION

**NOTE:** Make sure the All Items setting in the Discount Interval menu is set to OFF. See Discount All Items

1. Press Service Mode Button
2. Press 6 for Advanced Menu
3. Use number keys to enter Password (2314)
4. Press 1 for Discount
5. Press 3 for Selection
6. Use keypad to enter Selection number and discount price
7. Press # to save changes
8. Press  to exit to previous menu
9. Press 4 for Interval1 (up to 4 Intervals may be chosen)
10. Press 3 for Selection
11. Use number keys to enter Selection number
12. Press 1 to toggle ON/OFF
13. Press # to save changes
14. Press  to exit to previous menu
15. Press 4 for Day menu
16. Press 1 for All Days
17. Press 1 to toggle All Days ON/OFF
18. Press # to save changes
19. Press  to exit to previous menu
20. Press 2 for Monday menu
21. Repeat steps 17-19 as needed using 2 to toggle
22. Press 3 for Tuesday menu
23. Repeat steps 17-19 as needed using 3 to toggle
24. Press 4 for Wednesday menu
25. Repeat steps 17-19 as needed using 4 to toggle
26. Press 5 for Thursday menu
27. Repeat steps 17-19 as needed using 5 to toggle
28. Press 6 for Friday menu
29. Repeat steps 17-19 as needed using 6 to toggle
30. Press 7 for Saturday menu
31. Repeat steps 17-19 as needed using 7 to toggle
32. Press 8 for Sunday menu
33. Repeat steps 17-19 as needed using 8 to toggle
34. Press  to exit to previous menu
35. Press 5 for Start Time menu
36. Press # to edit
37. Use number keys to enter Start Time in 12-hr time format (HH:MM:SS) AM/PM

38. Press # to save changes
39. Press  to exit to previous menu
40. Press 6 for Stop Time menu
41. Press # to edit
42. Use number keys to enter Stop Time in 12-hr time format (HH:MM:SS) AM/PM
43. Press # to save changes
44. Press  to exit to previous menu
45. Press 7 for Enable Discount menu
46. Press 7 to toggle Enable ON/OFF
47. Press # to save changes
48. Press  to exit to previous menu

### SENSITIVITY ADJUST

Sets the coin tube value that will trigger the display to show Please Use Exact Change message. For example, if Exact Change is set to \$5.00, the message will display when the total of coins in the tube, as counted by the VMC, is at or below \$5.00 total.

1. Press Service Mode Button
2. Press 6 for Advanced Menu
3. Use number keys to enter Password (2314)
4. Press 2 for Exact Change
5. Press 1 to edit Exact Change
6. Use number keys to enter an amount
7. Press # to save changes
8. Press  to exit to previous menu

### ALTERNATE RULE

This function prevents a vend from occurring, flashes the Please Use Exact Change message and will return the established credit amount if one or more of the coin tubes are too low to give back the correct change for the vend.

**NOTE:** This setting must be OFF if using a bill validator only. If using a bill validator only, prices must be divisible by the denominations accepted by the bill validator.

1. Press Service Mode Button
2. Press 6 for Advanced Menu
3. Use number keys to enter Password (2314)
4. Press 2 for Exact Change
5. Press 2 to set Alt Rules
6. Press 2 to toggle ON/OFF (default ON)
7. Press # to save changes
8. Press  to exit to previous menu

### UNCONDITIONAL ACCEPTANCE



Sets the unconditional acceptance value. All cash box coins or bills equal to or less than this set value will be accepted, even if the changer cannot return an equal amount of change. When set to 0 (zero), all changer tube coins are accepted. Bills are accepted once there is enough change in the changer to pay back the bill type.

**NOTE:** The Unconditional Acceptance set value is adjustable, but the maximum value is equal to the largest denomination of currency or coin accepted by the changer or validator.

1. Press Service Mode Button
2. Press 6 for Advanced Menu
3. Use number keys to enter Password (2314)
4. Press 3 for Unconditional Acceptance menu
5. Use number keys to enter value
6. Press # to save changes
7. Press  to exit to previous menu

### **MAX CHANGE**

This option prevents change from being returned to the customer until the amount of credit has been reduced to a value less than or equal to the programmed maximum change limit.

1. Press Service Mode Button
2. Press 6 for Advanced Menu
3. Use number keys to enter Password (2314)
4. Press 4 for Max Change menu
5. Press 1 for current Max Change setting
6. Press 1 to toggle ON/OFF
7. Press # to save changes
8. Press  to exit to previous menu
8. Press 2 and use number keys to enter dollar amount
9. Press # to save changes
10. Press  to exit to previous menu

### **SHUTDOWN**

This menu sets the VMC to shut down All Items, by Row or by Selection, based on four (4) time of day intervals. If the time falls within one of these intervals and the entire machine has been selected for shutdown, then the message, "Vending Operation to Resume at hh.mm," will be displayed.







If a row or individual selection has been set for Shutdown, the same message displays once every time the customer makes that selection or selections (row).

**NOTE:** The correct time and date must be set so that the shutdown intervals work correctly. See Time and Date section of this manual. Also, for any given day these four time intervals may overlap each other. For each interval, the VMC can be programmed from no days up to every day of the week on which the specified shutdown time intervals are active.

### **SHUTDOWN BY ALL ITEMS**





1. Press Service Mode Button
2. Press 6 for Advanced Menu
3. Use number keys to enter Password (2314)
4. Press 5 for Shutdown
5. Press 1 for Interval1 (2 for Interval2, and so on)
6. Press 1 to for All Items
7. Press 1 to toggle ON/OFF





8. Press # to save changes
9. Press  to return to previous menu
10. Press 4 for Day menu
11. Press 1 for Every Day
12. Press 1 to toggle All Days ON/OFF
13. Press # to save changes
14. Press 2 for Monday menu
15. Press 2 to toggle Monday ON/OFF
16. Press # to save changes
17. Use numbers 3-8 to complete the other days of the week using steps 14 thru 16.
18. Press  to return to previous menu
19. Press 5 for Start Time menu
20. Press # to Edit
21. Use number keys to enter Start Time in 12-hr time format (HH:MM:SS) AM/PM
22. Press # to save changes
23. Press  to return to previous menu
24. Press 6 for Stop Time menu
25. Press # to Edit
26. Use number keys to enter Stop Time in 12-hr time format (HH:MM:SS) AM/PM
27. Press # to save changes
28. Press  to return to previous menu
29. Press 8 for Lighting menu
30. Press 8 to toggle Lighting ON/OFF
31. Press # to save changes
32. Press  to return to previous menu
33. Press 2, 3 or 4 to edit Intervals 2, 3 or 4
34. Press 9 for enable menu
35. Press 9 to toggle On/Off
36. Press # to save changes
37. Press  to exit to previous menu





## SHUTDOWN BY ROW

1. Press Service Mode Button
2. Press 6 for Advanced Menu
3. Use number keys to enter Password (2314)
4. Press 5 for Shutdown
5. Press 1 for Interval1 (2 for Interval2, and so on)
6. Press 2 for Row menu
7. Use number keys to enter Row number (First 2 character of any selections in the row)
8. Press 1 to toggle Row ON/OFF
9. Press # to save changes
10. Press  to exit to previous menu
11. Press 4 for Day menu
12. Press 1 for Every Day
13. Press 1 to toggle All Days ON/OFF
14. Press # to save changes
15. Press 2 Monday menu





16. Press 2 to toggle Monday ON/OFF
17. Press # to save changes
18. Use numbers 3-8 to complete the other days of the week using steps 15 thru 17.
19. Press  to return to previous menu
20. Press 5 for Start Time menu
21. Press # to Edit
22. Use number keys to enter Start Time in 12-hr time format (HH:MM:SS) AM/PM
23. Press # to save changes
24. Press  to return to previous menu
25. Press 6 for Stop Time menu
26. Press # to Edit
27. Use number keys to enter Stop Time in 12-hr time format (HH:MM:SS) AM/PM
28. Press # to save changes
29. Press  to return to previous menu
30. Press 8 for Lighting menu
31. Press 8 to toggle Lighting ON/OFF
32. Press # to save changes
33. Press  to return to previous menu
34. Press 2, 3 or 4 to edit Intervals 2, 3 or 4
35. Press 9 for enable menu
36. Press 9 to toggle On/Off
37. Press # to save changes
38. Press  to exit to previous menu

## SHUTDOWN BY SELECTION

1. Press Service Mode Button
2. Press 6 for Advanced Menu
3. Use number keys to enter Password (2314)
4. Press 5 for Shutdown
5. Press 1 for Interval1 (2 for Interval2, and so on)
6. Press 3 for Selection menu
7. Use number keys to enter Selection number
8. Press 1 to toggle Selection ON/OFF
9. Press # to save changes
10. Press  to exit to previous menu
11. Press 4 for Day menu
12. Press 1 for Every Day
13. Press 1 to toggle All Days ON/OFF
14. Press # to save changes
15. Press 2 Monday menu
16. Press 2 to toggle Monday ON/OFF
17. Press # to save changes
18. Use numbers 3-8 to complete the other days of the week using steps 15 thru 17.
19. Press  to return to previous menu
20. Press 5 for Start Time menu
21. Press # to Edit
22. Use number keys to enter Start Time in 12-hr time format (HH:MM:SS) AM/PM



23. Press # to save changes
24. Press  to return to previous menu
25. Press 6 for Stop Time menu
26. Press # to Edit
27. Use number keys to enter Stop Time in 12-hr time format (HH:MM:SS) AM/PM
28. Press # to save changes
29. Press  to return to previous menu
30. Press 8 for Lighting menu
31. Press 8 to toggle Lighting ON/OFF
32. Press # to save changes
33. Press  to return to previous menu
34. Press 2, 3 or 4 to edit Intervals 2, 3 or 4
35. Press 9 for enable menu
36. Press 9 to toggle On/Off
37. Press # to save changes
38. Press  to exit to previous menu

## ENERGY SAVINGS

1. Press Service Mode Button
2. Press 6 for Advanced Menu
3. Use number keys to enter Password (2314)
4. Press 6 for Energy Savings
5. Press 1 for Interval1 (2 for Interval2, and so on)
6. Press 1 for Day menu
7. Press 1 for Every Day
8. Press 1 to toggle All Days ON/OFF
9. Press # to save changes
10. Press  to exit to previous menu
11. Press 2 for Monday menu
12. Press 2 to toggle Monday ON/OFF
13. Press # to save changes
14. Press  to exit to previous menu
15. Use numbers 3-8 to complete the other days of the week using steps 11 thru 14.
16. Press  to exit to previous menu
17. Press 2 for Start Time menu
18. Press # to edit
19. Use number keys to enter Start Time in 12-hr time format (HH:MM:SS) AM/PM
20. Press # to save changes
21. Press  exit to previous menu
22. Press 3 for Stop Time menu
23. Press # to edit
24. Use number keys to enter Stop Time in 12-hr time format (HH:MM:SS) AM/PM
25. Press # to save changes
26. Press  to exit to previous menu
27. Press 4 to enter Storage Temp (default is 62°F)
28. Press 4 to edit Storage Temp (36°F to 62°F)

29. Press # to save changes
30. Press  to exit to previous menu
31. Press 5 for Lighting menu
32. Press 5 to toggle Lighting ON/OFF

**NOTE:** Lighting ON turns lights off during Energy Saving interval  
 Lighting OFF leaves lights on during Energy Saving interval

33. Press # to save changes
34. Press  to exit to previous menu
35. Press 6 for Enable menu
36. Press 6 to toggle ON/OFF
37. Press # to save changes
38. Press  to exit to previous menu

### PAIR MOTORS

This function allows two adjacent motors to run at the same time so that large, wide items can be accommodated. A coil and a rail change are also required.

1. Press Service Mode Button
2. Press 6 for Advanced Menu
3. Use number keys to enter Password (2314)
4. Press 7 for Pair menu
5. Use number keys to enter the first motor number
6. Press # and use number keys to enter the 2nd motor number
8. Press # to save changes
7. Press #-OK to add another pair of motors
8. Press  to exit to previous menu

### DEGREES

This function allows you to change from Fahrenheit to Celsius.

1. Press Service Mode Button
2. Press 6 for Advanced Menu
3. Use number keys to enter Password (2314)
4. Press 8 for Degrees menu
5. Press 8 to toggle between F and C
6. Press # to save changes
7. Press  to exit to previous menu

### DEGREES

This function allows you to change from Fahrenheit to Celsius.  
 This function allows you to change from Fahrenheit to Celsius.

1. Press Service Mode Button
2. Press 6 for Advanced Menu
3. Use number keys to enter Password (2314)

4. Press 8 for Degrees menu
5. Press 8 to toggle between F and C
6. Press # to save changes
7. Press  to exit to previous menu

## **CURRENCY**

This function allows you to change from Dollars to Rupees.

1. Press Service Mode Button
2. Press 6 for Advanced Menu
3. Use number keys to enter Password (2314)
4. Press 0 for Currency menu
5. Press 0 to toggle between \$ and Rs
6. Press # to save changes
7. Press  to exit to previous menu

## **7. MOTORS**

This function displays the motor count. It is a useful, quick diagnostic tool in case of selection failure and can point out a motor issue if the count is not correct.

1. Press Service Mode Button
2. Press 7 for Motor count display menu
3. Press  to exit to previous menu

## **8. TEST VEND**

This function tests the motor on one specified selection.

1. Press Service Mode Button
2. Press 8 for Selection motor test menu
3. Use number keys to enter selection to test and wait
4. Repeat for any other selections
5. Press  to exit to previous menu

## **9. ALL ITEMS**

This function tests all motors in sequence automatically. To stop the test, press  to exit.

**NOTE:** All selections should be empty prior to performing this test.

1. Press Service Mode Button
2. Press 9 for Selection motor test menu
3. Press  to exit to previous menu

## **10. TEST MODULES**

This menu contains diagnostic tests and settings for the following systems:

- Test Relays
- Optics
- Log
- All Aux Items
- Manual Defrost
- Door Switch
- On Door
- All Items

## TEST RELAYS

1. Press Service Mode Button
2. Press 0 for Test Modes
3. Press 1 to test relays
4. Press 1 to test Relay1
5. Press 1 to toggle relay ON/OFF
6. Press 2 to test Relay2
7. Press 2 to toggle relay ON/OFF
8. Repeat steps 6 and 7 for remaining relays 3 thru 6
9. Press  twice to exit to previous menu

## OPTICS

1. Press Service Mode Button
2. Press 0 for Test Modes
3. Press 2 for Optics alignment test
4. Press  to exit to previous menu

## LOG

1. Press Service Mode Button
2. Press 0 for Test Modes
3. Press 3 for Log
4. Use number keys to enter password (2314) to view log

**NOTE:** Do not use unless requested by trained personnel.

## ON DOOR

1. Press Service Mode Button
2. Press 0 for Test Modes
3. Press 4 for On Door
4. Press 4 to toggle SHOW ERRORS/OFF when door opens
5. Press  to exit to previous menu

## MANUAL DEFROST

1. Press Service Mode Button
2. Press 0 for Test Modes
3. Press 5 for Manual Defrost, which will enable you to set a manual defrost period for the machine
4. Press 5 to toggle ON/OFF
5. Press # to save changes
6. Press  to exit to previous menu

## DOOR SWITCH

1. Press Service Mode Button
2. Press 0 for Test Modes
3. Press 7 for Door Switch
4. Press 5 to toggle ON/OFF
5. Press # to save changes
6. Press  to exit to previous menu

## ERROR CODE MESSAGES

VMC Errors		
<i>Error Message</i>	<i>Description</i>	<i>Possible Solutions</i>
VMC Settings Reset	VMC has been reset to factory default.	If a software upgrade has just been performed, the VMC has been reset to default settings. Change your prices and other settings as required. Cycle power and verify your changes and any error messages.
VMC Door Switch	Door switch is seen as open for greater than the allowed time.	Check the door switch for correct operation. Check door wire harness.
VMC Scale Factor	There is a conflict with one or more MDB setting from the installed MDB devices.	Review manuals and settings for installed MDB devices to make sure they are compatible.
VMC Selection SW	A keypad selection button is stuck in the depressed position.	Determine reason why keypad button is stuck and repair.
VMC Low AC	The incoming AC power is lower than required to properly run your vending machine.	Determine why voltage is low. Remove any voltage reducing devices not authorized by the vending machine manufacturer.
VMC RAM Checksum	A RAM checksum error indicates that accounting data or a VMC setting was in error. The VMC will use a backup copy of the data where possible.	Check the VMC settings and accountability data for correctness. Cycle power to the vending machine and recheck error messages.

Motor Errors		
<i>Error Message</i>	<i>Description</i>	<i>Possible Solutions</i>
Motor [Number] Open	The motor indicated or harness to that motor has an open electrical connection.	Check the motor and motor harness for open connections. Test vend motor. Replace if necessary.
Motor [Number] Short	The motor or harness has an electrical short.	Check motor and motor harness for short. Replace if necessary.
Motor [Number] Home Sns	The motor home switch was not detected while the motor was in operation. This may also indicate a motor jam condition.	Check motor type service mode setting, motor, motor switch and then spiral for blockage. Test vend selection motor if necessary.
Motor [Number] Jam	A motor jam has been detected.	Check motor and spiral for blockage.

<b>Motor Errors</b>		
<b>Error Message</b>	<b>Description</b>	<b>Possible Solutions</b>
Motor [Number] Errors	One or more motor errors have been detected.	Test vend selection motor and review information on motor open, short, home switch and jam conditions.
Motor Under Voltage	The detected motor voltage is not high enough to run the selection motors.	Test vend selection motor for correct operation. Replace motor. Replace VMC.

<b>Temperature Sensor Errors (Refrigerated Models Only)</b>		
<b>Error Message</b>	<b>Description</b>	<b>Possible Solutions</b>
Refrig Sensor # Open	A temperature sensor or harness is considered to have an open electrical connection. Where # is the sensor number.	Check sensor and sensor harness for open connections. Check for sensor readings. Replace sensor if necessary.
Refrig Sensor # Short	A temperature sensor or harness is considered to have an electrical short. Where # is the sensor number.	Check sensor and sensor harness for shorted connections. Replace if necessary.
Refrig Health Safety	The cabinet temperature and time limit settings have been exceeded.	Check sensor readings and sensor harness for shorted connections. Check for sensor readings. Replace sensor if necessary.

<b>Vend Sensor Errors</b>		
<b>Error Message</b>	<b>Description</b>	<b>Possible Solutions</b>
Optical Sensor Error	The vend sensor is blocked, out of alignment or not detected.	Check sensor and sensor harness for open connections. Check for sensor readings. Replace sensor if necessary.

<b>Coin Changer Errors</b>		
<b>Error Message</b>	<b>Description</b>	<b>Possible Solutions</b>
Coin Mech Comm	VMC does not have communication with the coin changer.	Check MDB Harness to changer. Check for power on changer. See changer service manual.
Coin Mech Tube Sns	The coin changer has reported a tube sensor error.	See changer service manual.



<b>Coin Changer Errors</b>		
<b><i>Error Message</i></b>	<b><i>Description</i></b>	<b><i>Possible Solutions</i></b>
Coin Mech Inlet	The coin changer has reported an acceptor blockage.	Check changer tubes. See changer service manual.
Coin Mech Tube Jam	The coin changer has reported a tube payout error.	Check changer tubes. See changer service manual.
Coin Mech ROM	The coin changer has reported a program memory error.	See changer service manual.
Coin Mech Excess Esc	The coin changer has reported that a large number of coin escrow requests have occurred.	Check changer escrow lever position.
Coin Mech Coin Jam	The coin changer has reported that a coin is jammed in the coin path.	Check changer coin path. See changer service manual.
Coin Mech Low Accept	The VMC has seen a low acceptance rate on coins.	Review inserted coins. See changer service manual.
Coin Mech Accpt Disc	The coin changer has reported that the coin validation acceptor is disconnected.	Re-connect the coin changer's acceptor. See changer service manual.
Coin Mech Route Err	The coin changer reported that a coin did not follow the correct path.	Check changer coin path. See changer service manual.

<b>Bill Validator Errors</b>		
<b><i>Error Message</i></b>	<b><i>Description</i></b>	<b><i>Possible Solutions</i></b>
Bill Val Comm	VMC does not have communication with the bill validator.	Check MDB Harness to validator. Check for power on validator.
Bill Val Stack Full	The bill validator has reported that the stacker is full of bills.	Check bill stacker box for bills. See validator service manual.
Bill Val Motor Err	The bill validator reports that a validator motor error has occurred.	See validator service manual.
Bill Val Jam	The bill validator reports a bill is stuck in the bill path.	Check validator bill path for bills. See validator service manual.
Bill Val Stack Open	The bill validator is reporting a bill box is open or not installed.	Check bill stacker box for open lid. See validator service manual.
Bill Val Sensor Err	The bill validator reports a sensor error.	See validator service manual.

<b>Card Reader 1 and 2 Errors</b>		
<b>Error Message</b>	<b>Description</b>	<b>Possible Solutions</b>
Card RDR1 or 2 Comm	VMC does not have communication with the card reader.	Check MDB Harness to card reader. Check for power on card reader.
Card RDR1 or 2 Err	The card reader reports an error	See card reader service manual.

### **DELIVERY SYSTEM**

Your vendor consists of the Keypad, 2 Line VF Display, Driver Motors, Product Trays, Helix Coils and Delivery Bin. The customer inserts money and enters their selection on the Keypad. The selection's Driver Motor turns the Helix Coil that vends the product into the Delivery Bin.

### **PRODUCT TRAYS**

Your vendor features lock and release product trays. On the right side of each product tray you will find a Locking Lever (Fig. 14). To pull out the Product Tray, push down on the Locking Lever and roll toward you to load position.

**Fig. 14**



**Locking Lever**  
*beverage trays*



**Locking Lever**  
*snack trays*

### **PRICE SCROLLS AND SELECTION LABELS**

Price scrolls are fitted to each tray position. To adjust the pricing display, use your thumb or finger to rotate the scroll to show the desired price (Fig. 15). Note: this does not change the price of the item but only the display. The actual price must be changed via the service mode menus detailed in this manual. Note that there is a blank, white square at the end of the scroll case you need to write in a price not printed on the scroll.

**Fig. 15 – Adjustment of Price Display**



**Rotate DOWN to decrease**



**Rotate DOWN to decrease**

## REPLACE THE PRICE SCROLL

**Note** that the word “STOP” showing in the price display is an indication that you should stop rotating the scroll as the end has been reached. Should the scroll end become disengaged from the tray, simply remove the Selection Label and reinsert the scroll end. Rotate the scroll to the proper position and replace the Selection Label.

**Fig. 16 – Replace Price Scroll**



Blank white squares are available on the price scrolls just before the **STOP** indicator for custom pricing.

## VIGILANT VEND SENSOR SYSTEM

The Vigilant system is a series of infrared sensors that send a beam of light across the delivery bin. If this beam is broken by a product, the machine knows that an item was delivered to the customer. If this beam is not broken, the machine assumes that nothing was vended and turns the selection spirals by  $\frac{1}{4}$  turns until a product delivery is sensed. If, after the coils have turned a full revolution back to home without delivering a product, the customer will be asked to make another selection or to press the Coin Return button to receive their money back.

Certain products can be problematic for any vend sensing system. Products that are very thin or very small in size may, on occasion, miss the beams. With proper loading of the machine, sensing systems are irrelevant. A comfort level is provided to customers who walk up to the machine and know, through technology, they will not experience a “rip-off”. For this reason, a vend sensor system is desirable – however, if you vend very small or very thin items, you may want to consider turning off your sensing system in case of malfunction via product size. See the Service Mode section of this manual, Advanced menu, Rows and Columns sub-menu, for instructions.

The Vigilant sensors are located inside the delivery bin as shown in Figure 17. There is a red indicator light located on the left side when viewing the bin from the inside with the door open. This light should be lit when the system is on, indicating that there is power to the system. Blocking any of the beams turns off the red indicator light, which means the system is working correctly.

**Fig. 17 Vend Sensor System**

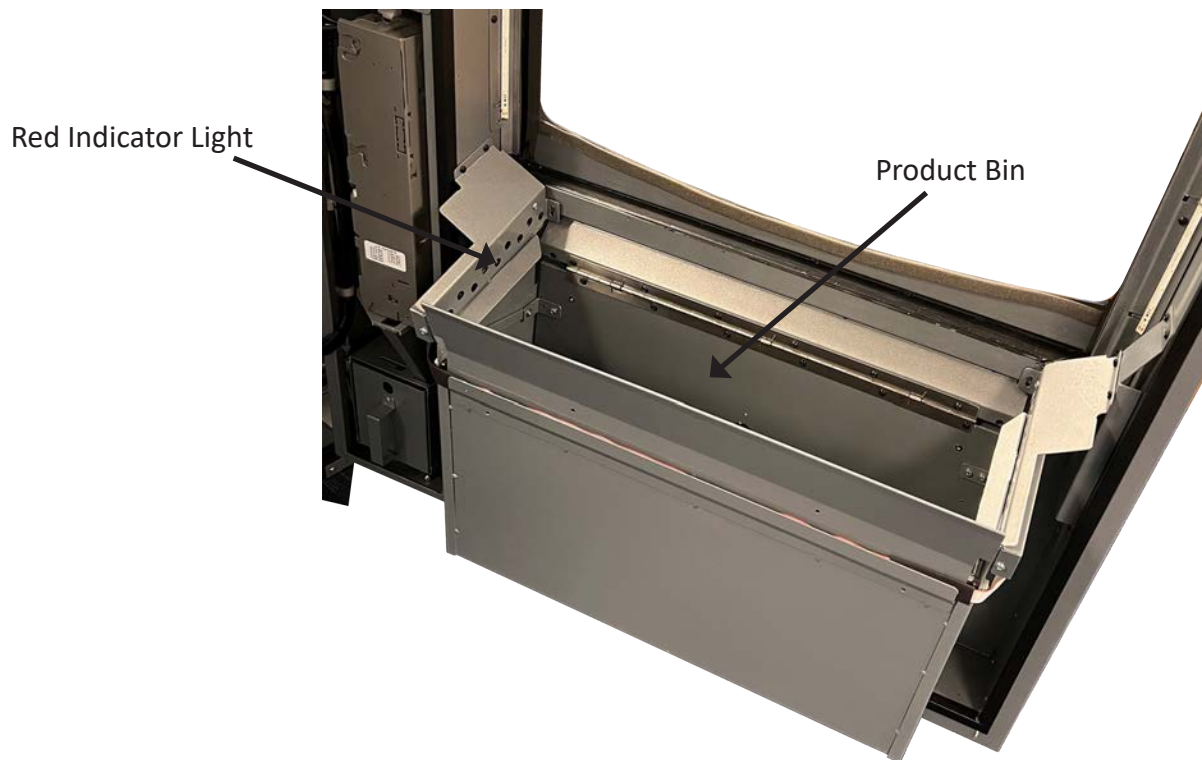

**Note:** When performing Motor Tests without product loaded, it is a good idea to shut off the Vigilant system.

## TROUBLESHOOTING

### **1. NO DISPLAY ON THE FRONT PANEL**

- a. Harness may be unplugged
- b. Transformer fuse tripped
- c. Restart machine
- d. Faulty display harness
- e. Display board defective

### **2. SELECTION WILL NOT VEND**

- a. Disconnected tray wire harness
- b. Viligent vend sensor may be blocked, if enabled
- c. Vend mechanism binding on tray
- d. Product jammed
- e. Tray or Motor connection unplugged or faulty connection
- f. Defective motor

### **3. MULTIPLE VENDS FROM ONE SELECTION**

- a. Viligent vend sensor malfunction, if enabled
- b. Defective motor switch
- c. Viligent vend sensor may be blocked, if enabled

### **4. MULTIPLE VENDS MORE THAN ONE SELECTION SIMULTANEOUSLY**

- a. Defective motor
- b. Motor harness not plugged into the vend motor correctly
- c. Tray cable faulty

### **5. UNIT WILL NOT ACCEPT MONEY**

- a. All Prices are set to zero or machine is set to Free Vend
- b. Will not accept bill if coins in coin changer below the minimum level
- c. Will not accept more than one bill if the bill equal or exceeds the highest priced item.
- d. No power to system control board
- e. Coin Mechanism or Bill acceptor defective.

## 7. MACHINE WILL NOT COOL

- a. Press the “#” key on the keypad to get a temperature reading
- b. Verify that Temp Set is 43° F in Service Mode. Note: Setting the temperature too cold will put your evaporator at risk of freezing up.
- c. Verify that all fans are running
- d. Clean the condenser
- e. Remove your refrigeration deck and inspect for ice.

**Q: I rearranged my trays and now some selections don't work. Display says Make Alternate Selection.**

**A:** Enter the service mode, press “7” to home & count motors. The motors will now be automatically updated.

**Q: My machine will not take in bills but accepts change ok.**

**A:** Several options here but the most common especially when first setting up the machine is that there is not enough change in the changer. By looking at the display it will give you a clue as to what may be wrong. If the display reads “Please Insert Exact Money....” that indicates there is not enough change in the changer. Fill the coin tubes completely full. Completely full means you can't get any more change into the coin tube. Press the coin return button and the display should show Canceling. The display should now show “Please Insert Money.....” without the word Exact.

**Q: My machine still will not accept bills and the display does not indicate exact change.**

**A:** If the validator takes in the bill partially but ejects it back out, that indicates that the bill may be unacceptable or the validator needs cleaning. Check for a jammed bill behind the bill box. Follow the validator manufacturer's recommendation for cleaning.

**Q: My machine will accept \$1 bills but not \$5 bills.**

**A:** This situation can depend on several factors. Make sure the bill validator is set to accept \$5 bills. The amount of change being reported in the changer must accommodate the highest vending price in the machine, so make sure the changer is full of change. If you are vending high priced items you may need to replace the changer with a larger capacity model.

**Q: My machine will not accept the new \$5 bills.**

**A:** Contact the bill validator manufacturer for upgrade instructions. Not accepting currency that has been changed due to a Federal Government mandate is not covered under our manufacturer's warranty.

**Q: My machine will vend a product, display Vend Error then give my money back or allow me take make an alternate selection.**

**A:** This indicates there is a problem detected with the vend motor. Each vend motor has a small micro switch inside that indicates when the motor has made one full revolution and returns back to what is referred to as the “home position”. If this signal is not received back to the controller in a specified amount of time the controller will indicate an error and refund the money. The problem could be in an individual motor itself, the tray wire harness or any connection in between the tray to the control board. If the whole tray acts this way that usually indicates that the tray harness or any connection in between to the controller may be bad. If it is an individual motor, the motor count you see when entering service mode will not have the correct count. The easiest way to troubleshoot this situation would be to swap tray connections where the tray harness plug plugs into the machine. For example if the problem appears on tray 1, unplug tray 1 and tray 2 (assuming they both have the same number of selections), swap the connections and plug tray 1 into tray 2 receptacle and vice versa. Now do your test vending by selecting the tray 2 selections on the keypad and the tray 1 should operate. If the problem follows the tray then suspect either the motor or the tray cable harness. If the problem stays with the A receptacle and now the B tray exhibits the problem then the problem is in a connection somewhere between the A receptacle and the controller board. Make sure to examine any and all connections for any loose wires, etc.

**Q: My display is dead or intermittent but the rest of the machine appears to be working.**

**A:** Check the gray flat ribbon cable connection between the display and the controller board to insure the plugs are plugged in securely.

**Q: My machine will not cool.**

**A:** **1.** Make sure the machine programming is set up properly. Factory setting is 43°F. Setting the machine any lower could cause the machine to freeze up.

**2.** Inspect the evaporator coil to see if it may be frozen over. Using a flashlight shine it into the evaporator fan located under the bottom tray. You are looking for aluminum fins behind the fan motor. If they are completely white or solid with ice this will keep the air from flowing properly and cause the machine to not cool. To thaw out remove the 4 prong condensing unit plug, not the evaporator fan plug and just close the door and let set for overnight to insure it completely defrosts. Be prepared in case the defrost water pan overflows on the floor. You may need to set some towels around and under the machine to catch any overflow. After the machine is thawed completely out you will want to check the temperature settings to insure they are not set too cold.

**3.** Check the door switch. The easiest test is to close the door, then while opening the door watch the display to see if you see the message No Errors and hear an audible beep. If you do not then suspect the door switch may need adjustment. You can reach over the door and press it manually while watching the display to see if it works.

**4.** As a manual test of the cooling system you can enter the Test Mode section of the menu and select the Test Relays function. Relay 1 controls the condensing unit, and Relay 2 controls the evaporator fan. If either one does not turn on while testing, then suspect a relay has quit working or connection has become loose.

**Q: My machine will not cool.**

**A:**    **1.**     Make sure the machine programming is set up properly. Factory setting is 39°F. Setting the machine any lower could cause the machine to freeze up.

**2.**     Inspect the evaporator coil to see if it may be frozen over. Using a flashlight shine it into the evaporator fan located under the bottom tray. You are looking for aluminum fins behind the fan motor. If they are completely white or solid with ice this will keep the air from flowing properly and cause the machine to not cool. To thaw out remove the 4 prong condensing unit plug, not the evaporator fan plug and just close the door and let set for overnight to insure it completely defrosts. Be prepared in case the defrost water pan overflows on the floor. You may need to set some towels around and under the machine to catch any overflow. After the machine is thawed completely out you will want to check the temperature settings to insure they are not set too cold.

**3.**     Check the door switch. The easiest test is to close the door, then while opening the door watch the display to see if you see the message No Errors and hear an audible beep. If you do not then suspect the door switch may need adjustment. You can reach over the door and press it manually while watching the display to see if it works.

**4.**     As a manual test of the cooling system you can enter the Test Mode section of the menu and select the Test Relays function. Relay 1 controls the condensing unit, and Relay 2 controls the evaporator fan. If either one does not turn on while testing, then suspect a relay has quit working or connection has become loose.

**CAUTIONS:**

**1.** High voltage is located in the area of the unit and could cause injury or death.

**2.** Replacement of the bill acceptor, coin changer, front panel display, system control board or vend motors should only be performed by trained personnel with power disconnected from the vending machine.



# Wiring Diagrams

Ambient

## WIRING DIAGRAM ENVISION AMBIENT MODELS

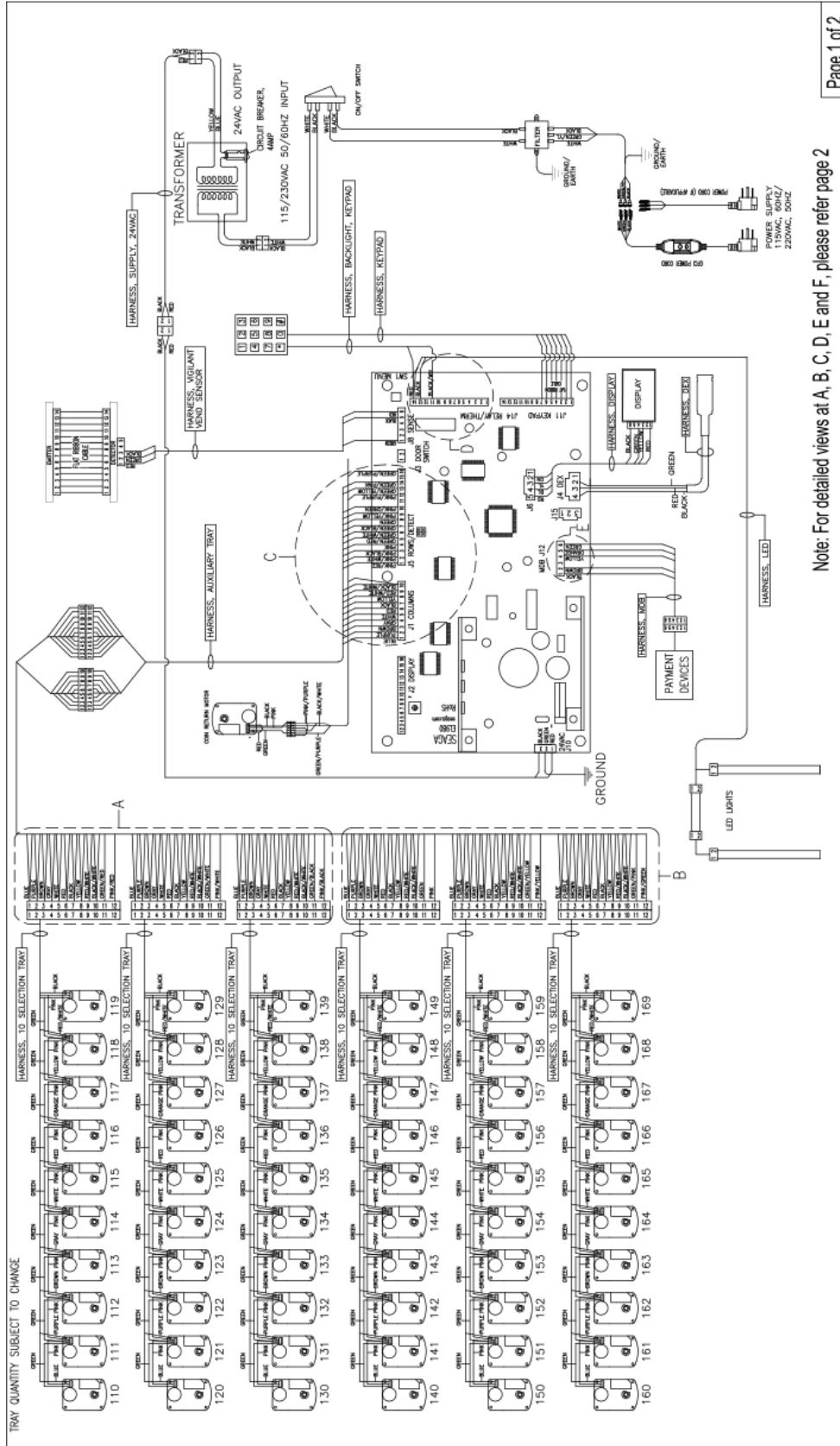

# Wiring Diagrams

Ambient

## WIRING DIAGRAM ENVISION AMBIENT MODELS

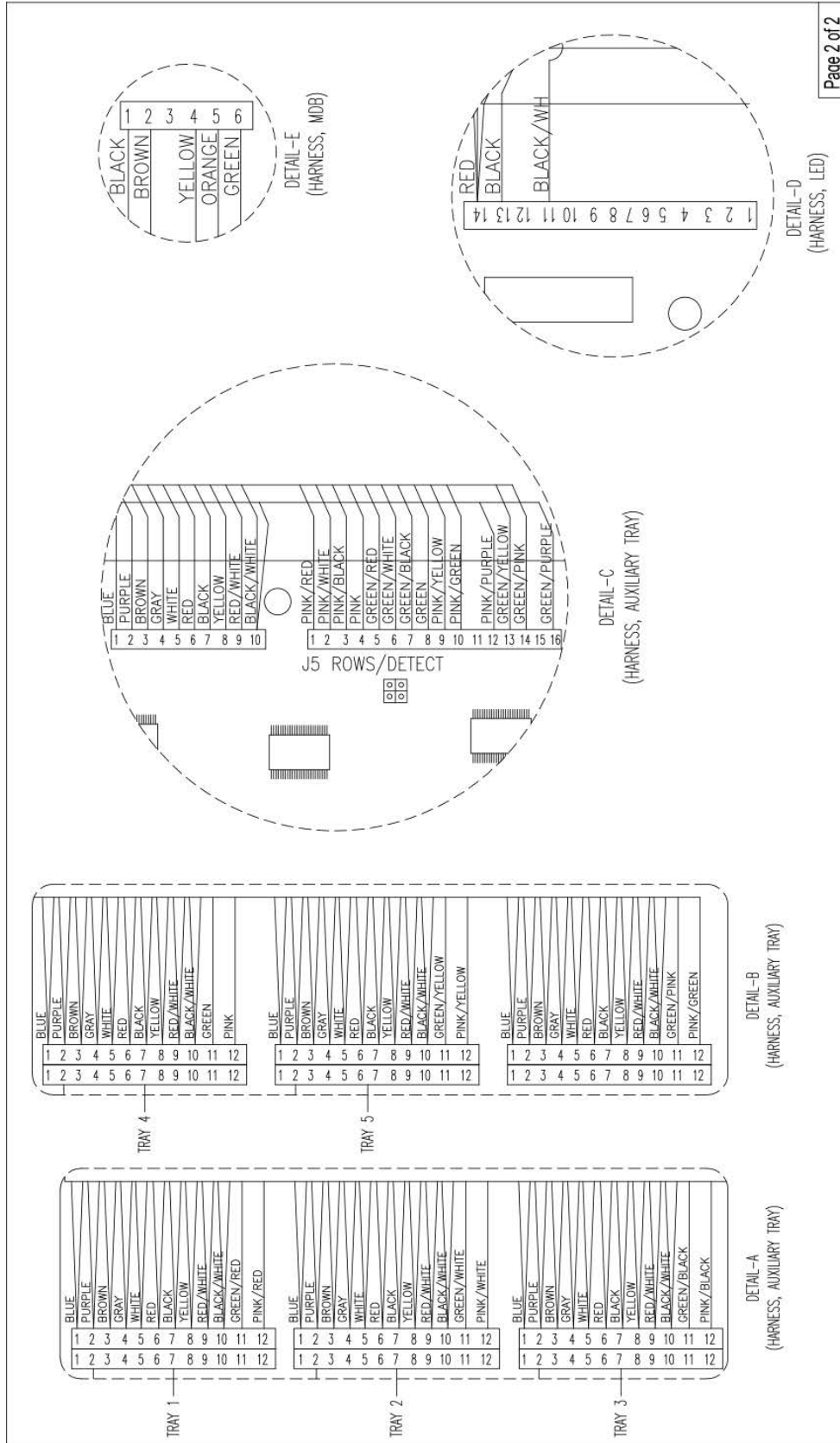

# Wiring Diagrams

Refrigerated

## WIRING DIAGRAM ENVISION REFRIGERATED MODELS

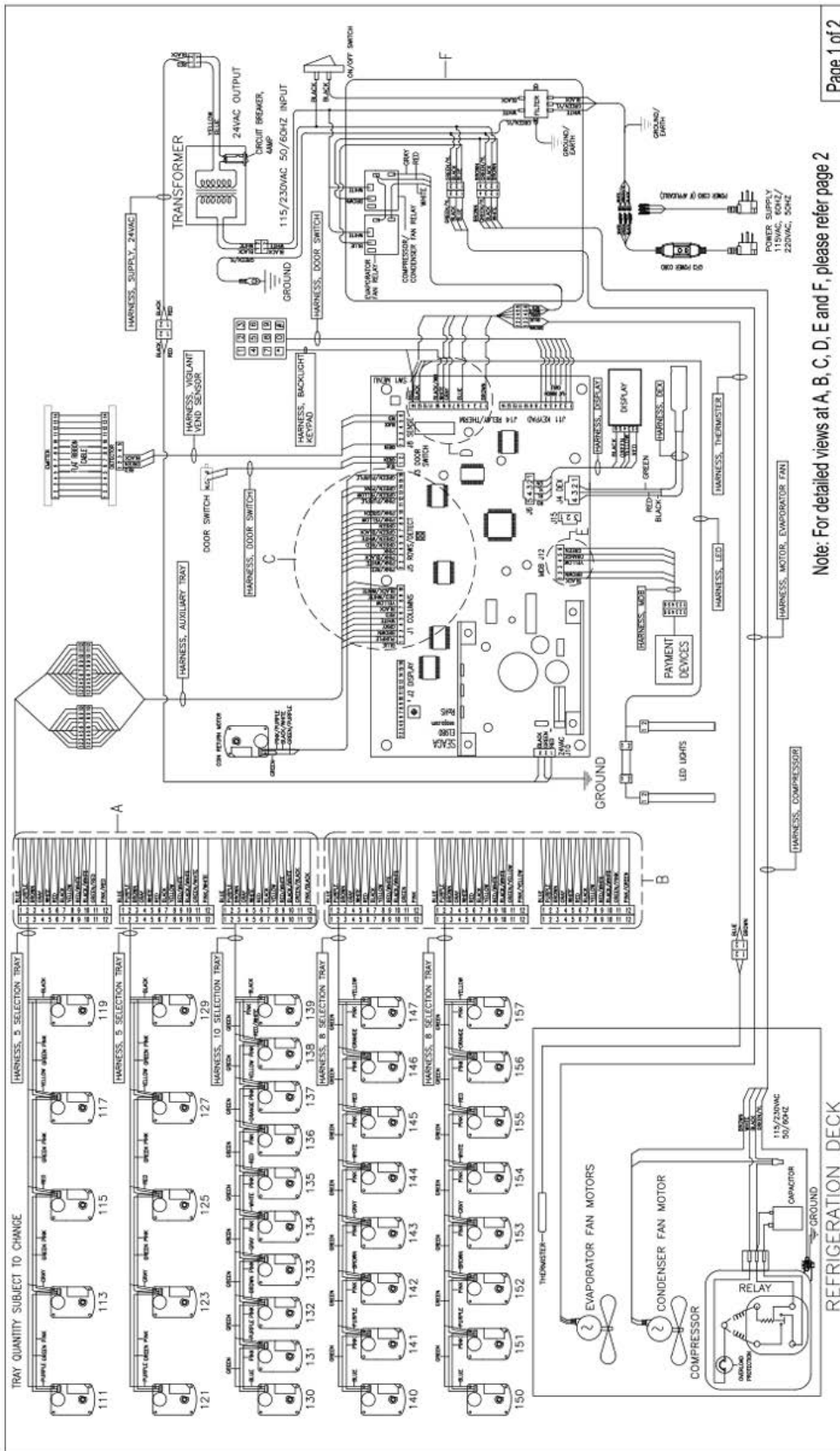

Note: For detailed views at A, B, C, D, E and F, please refer page 2

# Wiring Diagrams

Refrigerated

## WIRING DIAGRAM ENVISION REFRIGERATED MODELS

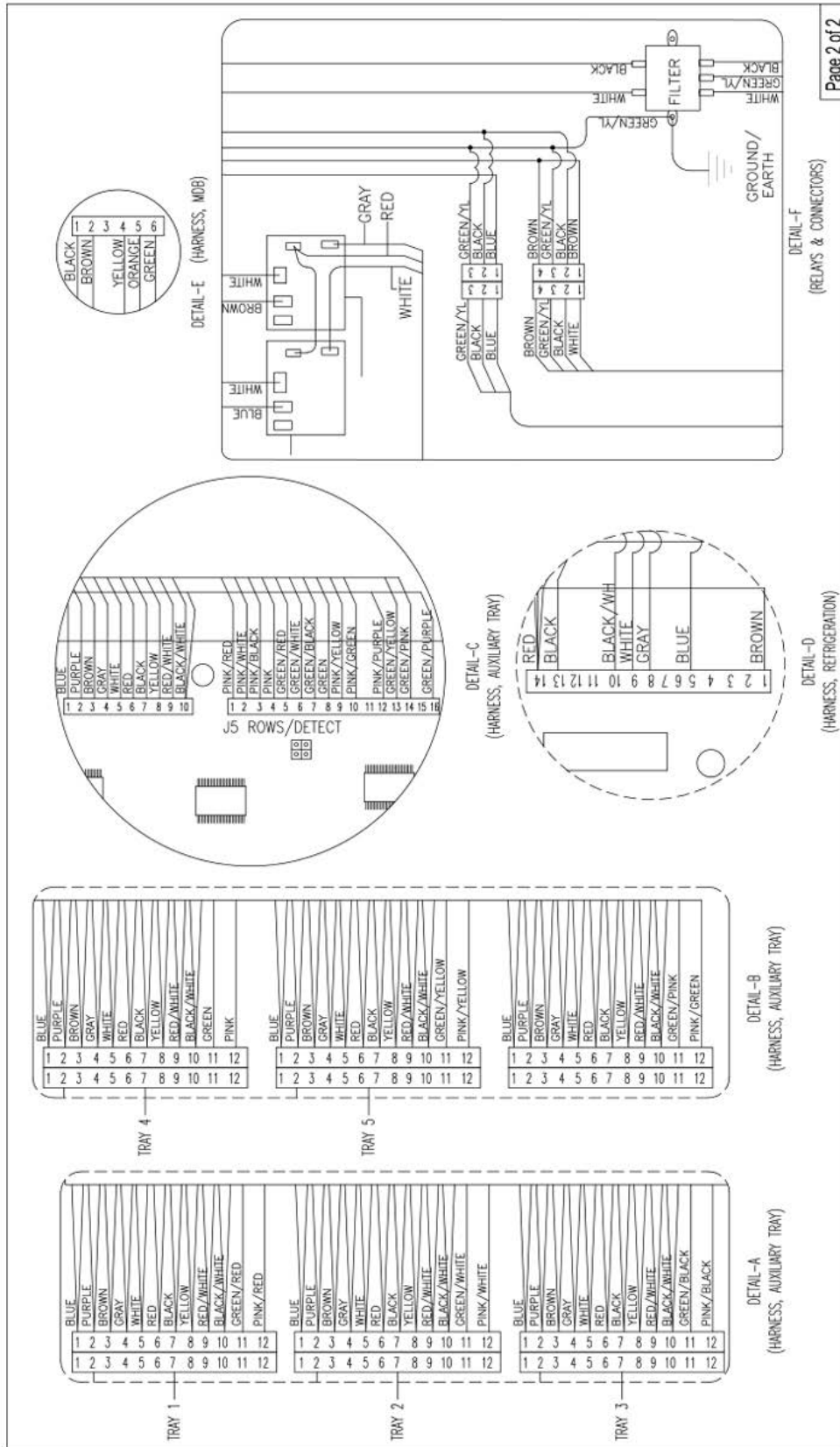

**Machine Assemblies**  
**Ambient Cabinet Assembly (ENV5S)**

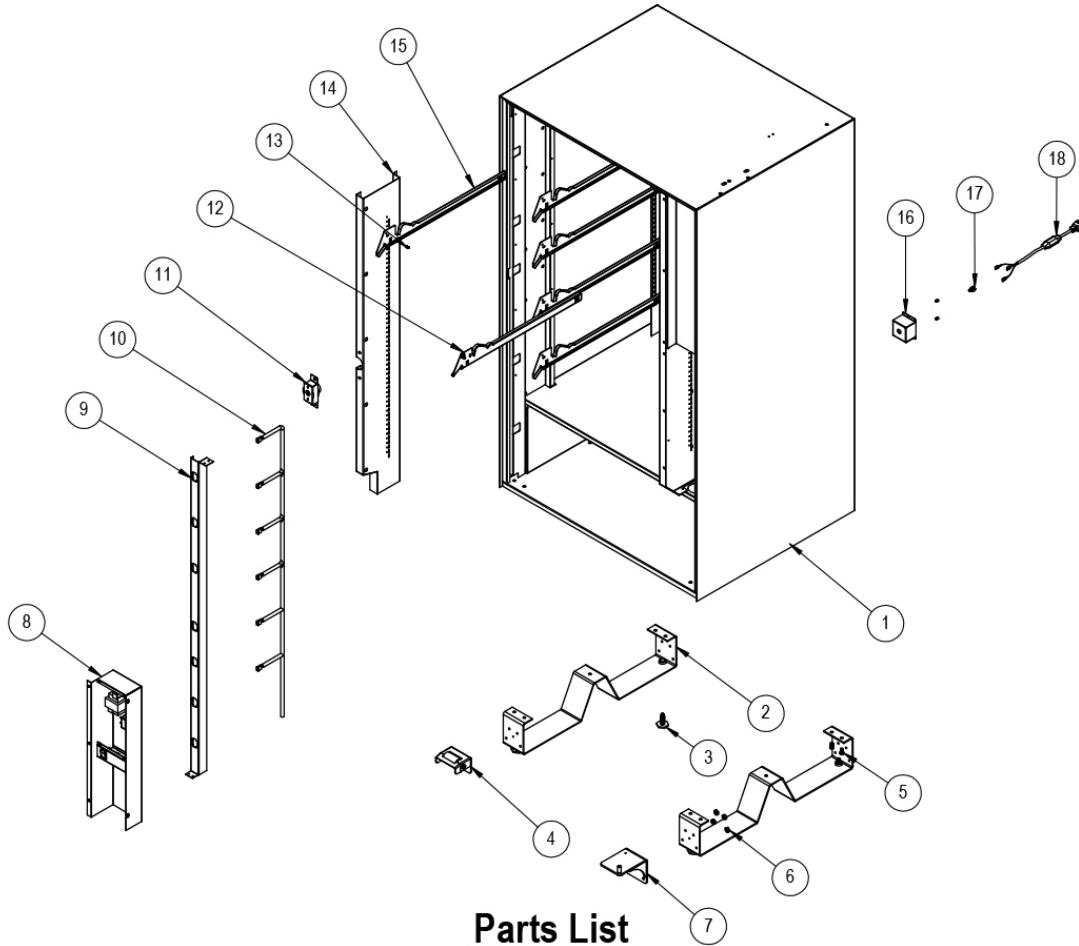

**Parts List**

ITEM NO.	PART NO.	DESCRIPTION	QTY.
1	SAI88002C	CABINET	1
2	STI574	LEGS	2
3	HAI955	LEVELER	4
4	SAI833	DOOR SUPPORT ROLLER ASSEMBLY	1
5	FAI921	BOLT	16
6	FAI924A	HEX NUT	16
7	STI575	BOTTOM HINGE	1
8	SAI88004	ELECTRICAL BOX	1
9	STI70091	BRACKET TRAY CONNECTOR	1
10	ELI2373	HARNESS	1
11	SAI827	CAGE NUT ASSEMBLY	1
12	STI901	RAIL TRAY RIGHT	6
13	FA513	SCREW	25
14	STI70035A	BRACKET LEFT FRONT	1
15	STI900	RAIL TRAY LEFT	6
16	STI57029	BRACKET POWER CORD	1
17	HAI799	STRAIN RELIEF	1
18	ELC959	POWER CORD GFCI	1

## Refrigerated Cabinet Assembly ENV5B/ENV5C

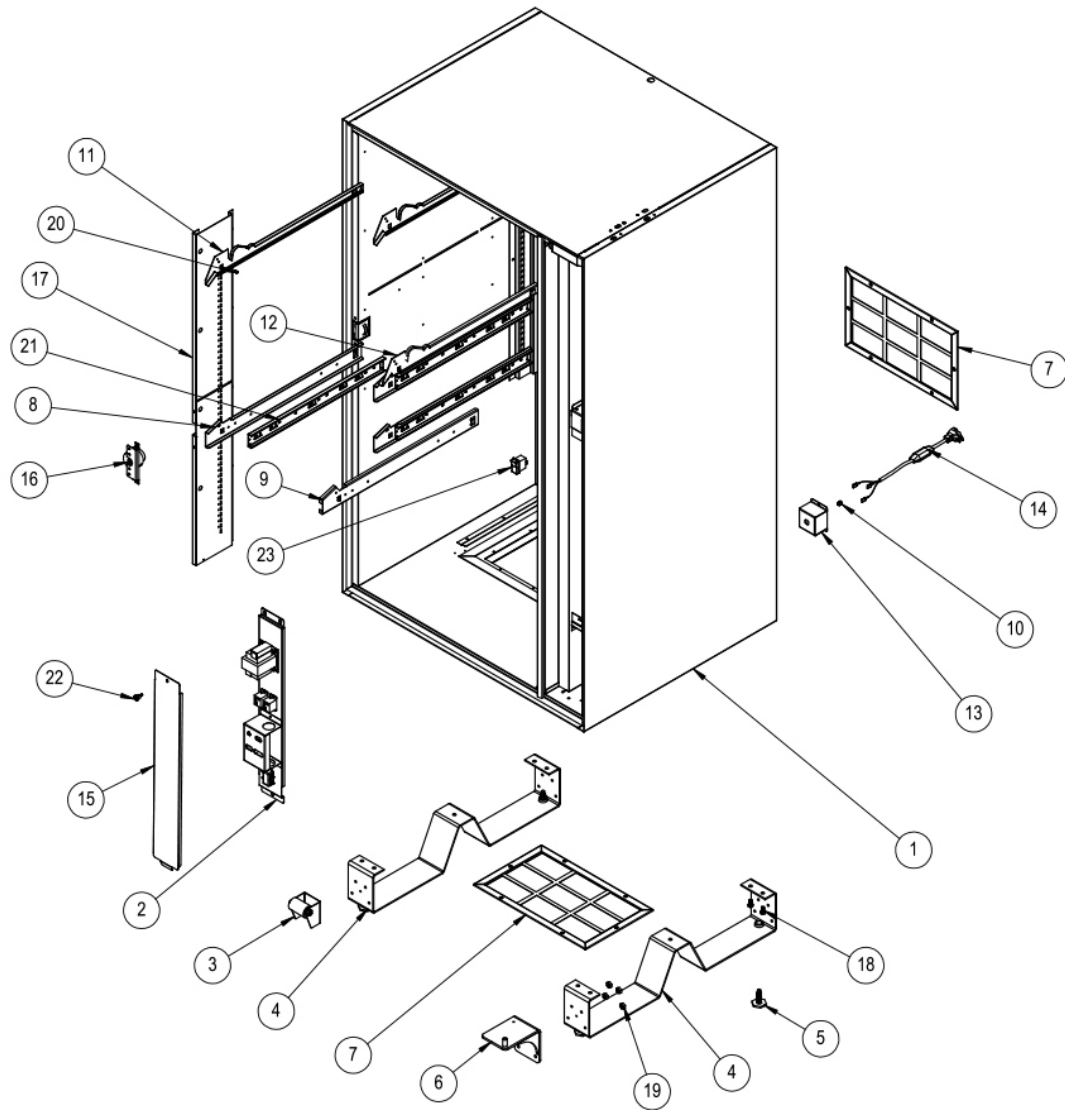

### Parts List

ITEM NO.	PART NO.	DESCRIPTION	QTY.	ITEM NO.	PART NO.	DESCRIPTION	QTY.
1	SAI87001A	CABINET	1	13	STI57029	BRACKET POWER CORD	1
2	SAI793A	ELECTRICAL PANEL ASSEMBLY	1	14	ELC959	POWER CORD GFCI	1
3	SAI764A	DOOR SUPPORT ROLLER ASSEMBLY	1	15	STI87001	COVER ELECTRICAL PANEL	1
4	STI574	LEGS	2	16	SAI828	CAGE NUT ASSEMBLY	1
5	HAI955	LEVELER	5	17	STI87155	BRACKET LEFT FRONT	1
6	STI648	BOTTOM HINGE	1	18	FAI956	BOLT	16
7	STI58022	GRILL REAR & BOTTOM	2	19	FAI924A	HEX NUT	16
8	STI579	RAIL BEVERAGE TRAY LH	3	20	FA513	SCREW	25
9	STI579A	RAIL BEVERAGE TRAY RH	3	21	HAI821	RAIL TELESCOPIC 22"	6
10	HAI799	STRAIN RELIEF	1	22	PLI613	KNOB	1
11	STI900	RAIL TRAY LEFT	3	23	ELI2386	SWITCH	1
12	STI901	RAIL TRAY RIGHT	3				

## Ambient Door Assembly ENV5S

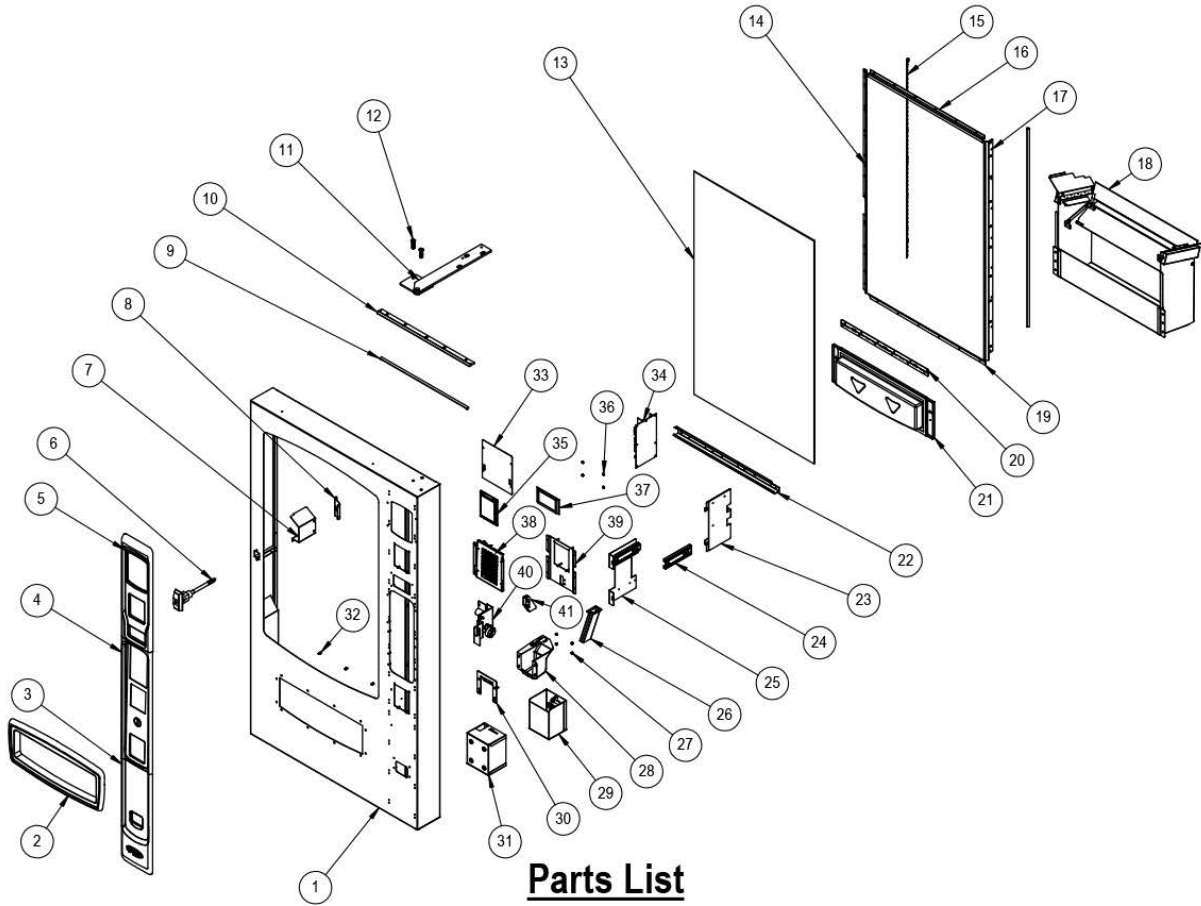

### Parts List

ITEM NO.	PART NO.	DESCRIPTION	QTY.
1	SAI88017A	DOOR	1
2	PLI2234	BEZEL DELIVERY DOOR	1
3	PLI2233	BEZEL BOTTOM	1
4	PLI2232	BEZEL MIDDLE	1
5	PLI2231	BEZEL TOP	1
6	HAC959	T-HANDLE	1
7	STI70075	COVER DOOR LOCK	1
8	SAI70024	BRACKET GUIDE T-HANDLE	1
9	ELC2369	LED LIGHT	1
10	STI87147	BRACKET LED TOP	1
11	SAI777	HINGE TOP	1
12	FA520	SCREW	2
13	GLI953	GLASS DOOR	1
14	STI88099	BRACKET GLASS/LED HOLDING LH	1
15	ELC2370	LED LIGHT	2
16	STI88010	BRACKET GLASS HOLDING TOP	1
17	STI88100	BRACKET GLASS/LED HOLDING RH	1
18	SAI88018	DELIVERY BIN	1
19	STI89041	BRACKET GLASS HOLDING BOTTOM	1
20	HAI2074	HINGE	1
21	SAI87073A	DELIVERY DOOR	1

ITEM NO.	PART NO.	DESCRIPTION	QTY.
22	STI87140	BRACKET HINGE DELIVERY DOOR	1
23	STI87171	BRACKET COIN CHANGER MOUNTING	1
24	HAC2091	RAIL TELESCOPIC	2
25	STI87170	BRACKET SLIDE HOLDING REAR	1
26	SAI87075	COIN RETURN CHUTE	1
27	FAI856	HEX NUT	34
28	PLI2235	COIN RETURN CUP	1
29	SAI87034	COIN BOX	1
30	STI87151	SECURITY BRACKET	1
31	SAI87074	COIN BOX GUIDE	1
32	FAI891	SCREW	38
33	STI87163	BACK PLATE TOUCH SCREEN	1
34	EL980	VMC	1
35	PLI2249	PLUG BV	2
36	FAI881	NUT	4
37	ELC2422	DISPLAY	1
38	SAI824	KEYPAD ASSEMBLY	1
39	STI87161	BRACKET BV MOUNTING	1
40	SAI87077	COIN RELEASE ASSEMBLY	1
41	SAI87076	COIN INSERT CHUTE	1

## Refrigerated Door Assembly ENV5B/ENV5C

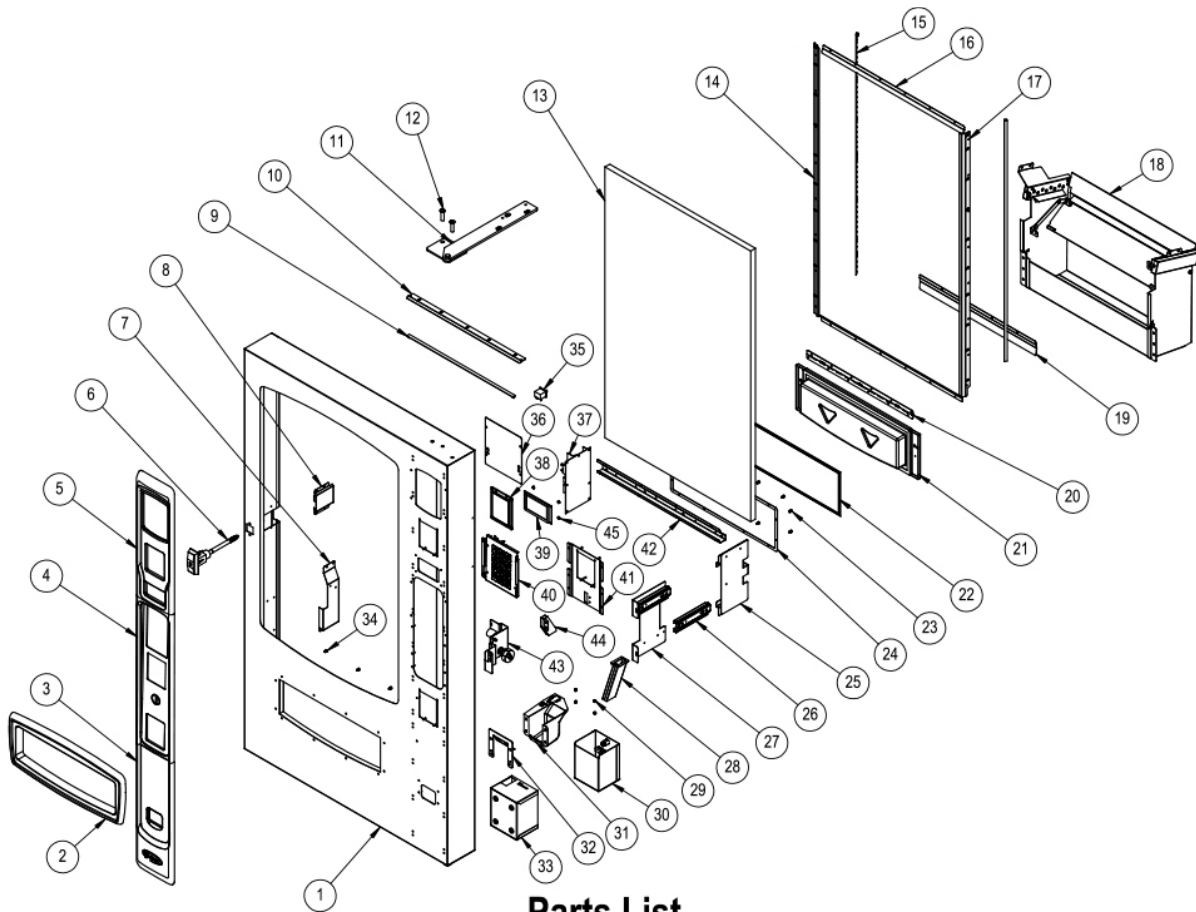

### Parts List

ITEM NO.	PART NO.	DESCRIPTION	QTY.
1	SAI87072B	DOOR	1
2	PLI2234	BEZEL DELIVERY DOOR	1
3	PLI2233	BEZEL BOTTOM	1
4	PLI2232	BEZEL MIDDLE	1
5	PLI2231	BEZEL TOP	1
6	HAC959	T-HANDLE	1
7	STI87026A	BRACKET PRODUCT GUIDE	1
8	STI87156	COVER DOOR LOCK	1
9	ELC2369	LED LIGHT	1
10	STI87147	BRACKET LED TOP	1
11	SAI777	HINGE TOP	1
12	FA520	SCREW	2
13	GLI967	GLASS DOOR	1
14	STI87145	BRACKET GLASS/LED HOLDING LH	1
15	ELC2370	LED LIGHT	2
16	STI87028	BRACKET GLASS HOLDING TOP/BOTTOM	2
17	STI87146	BRACKET GLASS/LED HOLDING RH	1
18	SAI785A	DELIVERY BIN	1
19	STI87015	MINT BRACKET	1
20	HAI2074	HINGE	1
21	SAI87073A	DELIVERY DOOR	1
22	PLI2227	GASKET DELIVERY DOOR	1
23	FAI987	SCREW	90

ITEM NO.	PART NO.	DESCRIPTION	QTY.
24	STI87141	GASKET RETAINER	1
25	STI87171	BRACKET COIN CHANGER MOUNTING	1
26	HAC2091	RAIL TELESCOPIC	2
27	STI87170	BRACKET SLIDE HOLDING REAR	1
28	SAI87075	COIN RETURN CHUTE	1
29	FAI856	HEX NUT	34
30	SAI87034	COIN BOX	1
31	PLI2235	COIN RETURN CUP	1
32	STI87151	SECURITY BRACKET	1
33	SAI87074	COIN BOX GUIDE	1
34	FAI891	SCREW	38
35	ELC2385	DOOR SWITCH	1
36	STI87163	BACK PLATE TOUCH SCREEN	1
37	EL980	VMC	1
38	PLI2249	PLUG BV	2
39	ELC2422	DISPLAY	1
40	SAI824	KEYPAD ASSEMBLY	1
41	STI87161	BRACKET BV MOUNTING	1
42	STI87140	BRACKET HINGE DELIVERY DOOR	1
43	SAI87077	COIN RELEASE ASSEMBLY	1
44	SAI87076	COIN INSERT CHUTE	1
45	FAI881	HEX NUT	4



## Refrigeration Deck Assembly ENV5B/ENV5C

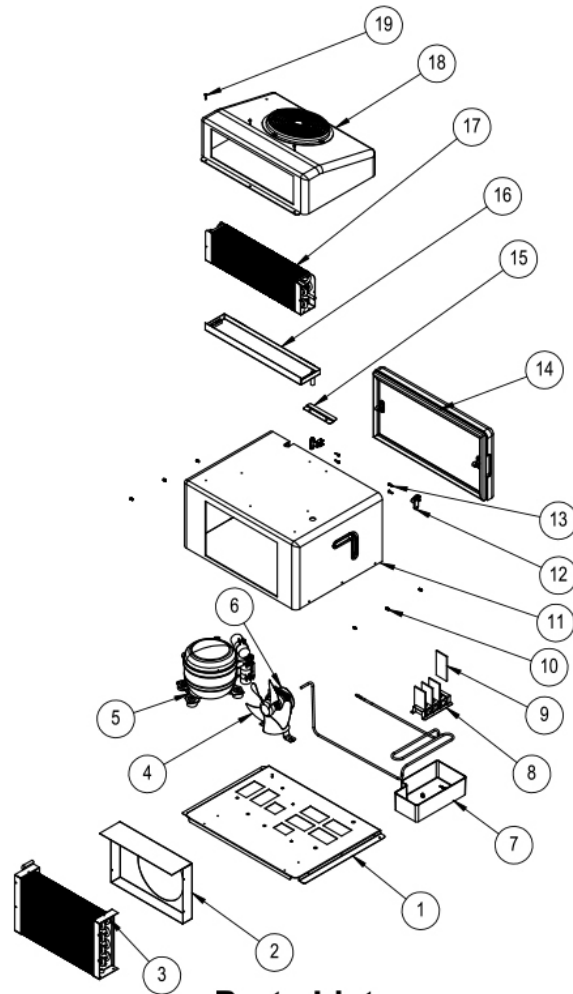

### Parts List

ITEM NO.	PART NO.	DESCRIPTION	QTY.
1	STI87164	BASE REFRIGERATION DECK	1
2	STI87037	SHROUD CONDENSER	1
3	REC926	CONDENSER	1
4	REI861	FAN BLADE	1
5	REI925	COMPRESSOR	1
6	REC928	MOTOR	1
7	PLI2086	TRAY CONDENSATE	1
8	VS198	BRACKET SPONGE PAD	1
9	REC355	SPONGE	4
10	FAI884	SCREW	18
11	SAI87011A	TOP COVER	1
12	PLI2242	BALL CATCHER FEMALE	2
13	FAI886	SCREW	4
14	SAI87012A	COVER FRONT REFRIGERATION DECK	1
15	STI87168	LOCKING BRACKET EVAPORATOR HOUSING	1
16	SAI87013A	TRAY EVAPORATOR	1
17	REC933	EVAPORATOR	1
18	SAI87078	EVAPORATOR HOUSING	1
19	FAI933	SCREW	7

## Evaporator Housing Assembly ENV5B/ENV5C

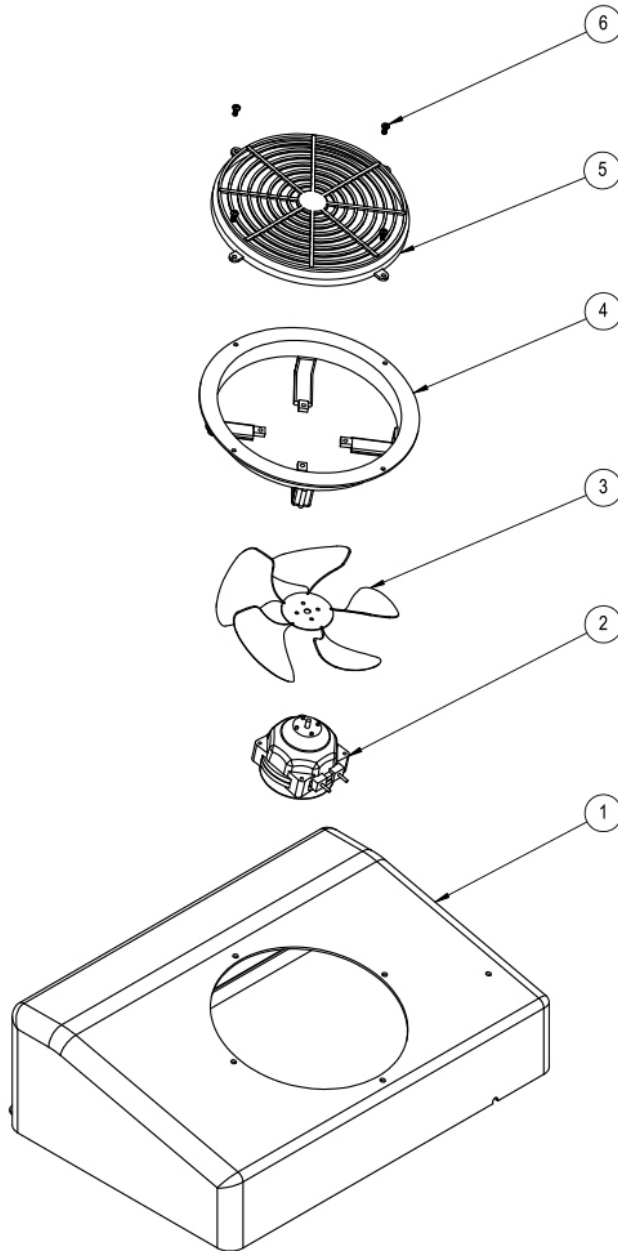

### Parts List

ITEM NO.	PART NO.	DESCRIPTION	QTY.
1	PLI2248	EVAPORATOR HOUSING	1
2	REC928	MOTOR	1
3	REI914	FAN BLADE	1
4	PLI955	BRACKET EVAPORATOR MOTOR	1
5	PLI954	FAN GUARD	1
6	FAI932	SCREW	4

## Cover Front Refrigeration Deck Assembly ENV5B/ENV5C

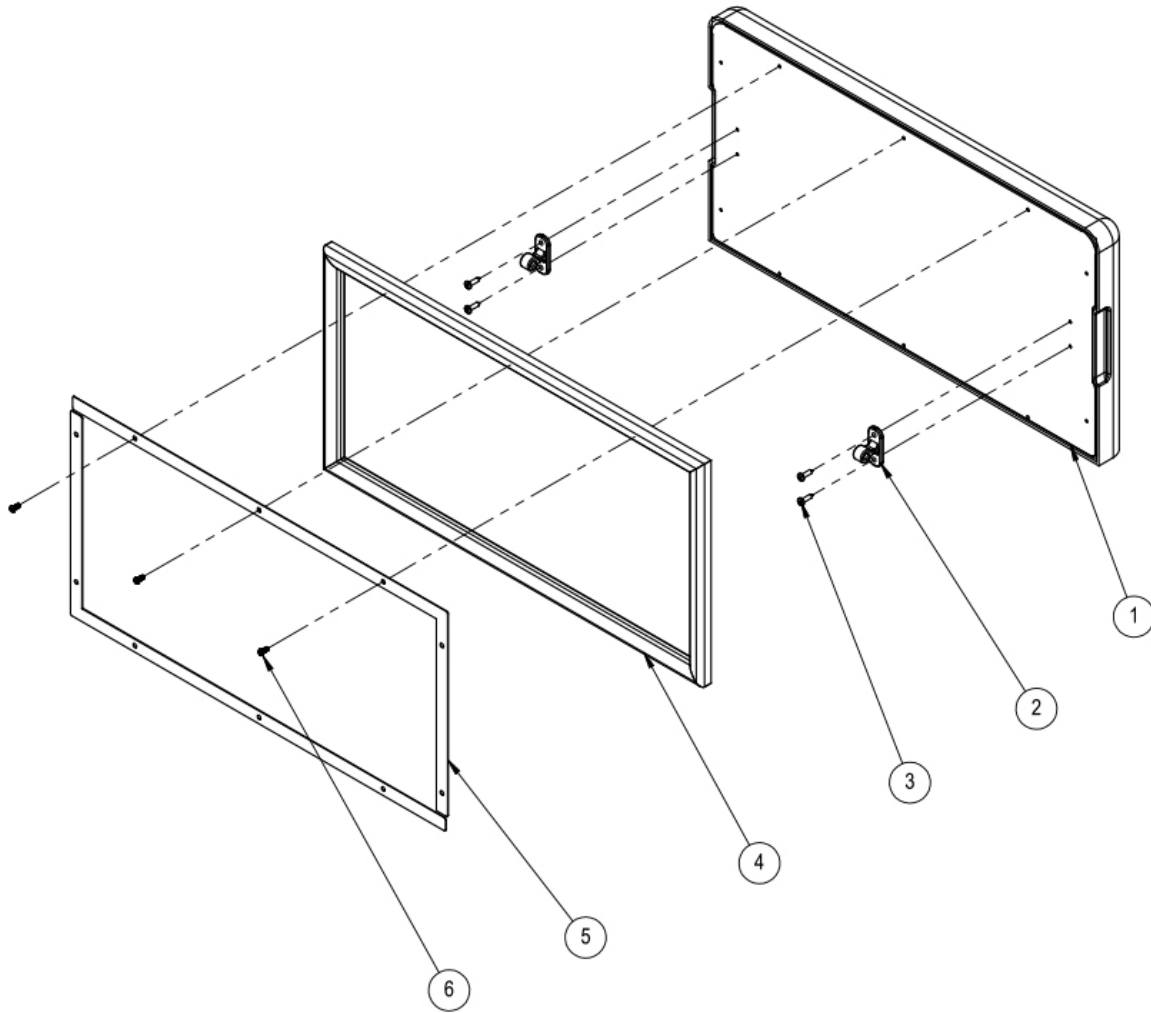

### Parts List

ITEM NO.	PART NO.	DESCRIPTION	QTY.
1	SAI87012A	COVER FRONT	1
2	PLI2241	BALL CATCHER MALE	2
3	FAI886	SCREW	4
4	PLI2030A	GASKET	1
5	STI87169	GASKET RETAINER	2
6	FAI884	SCREW	10

## Ambient Delivery Bin Assembly ENV4S

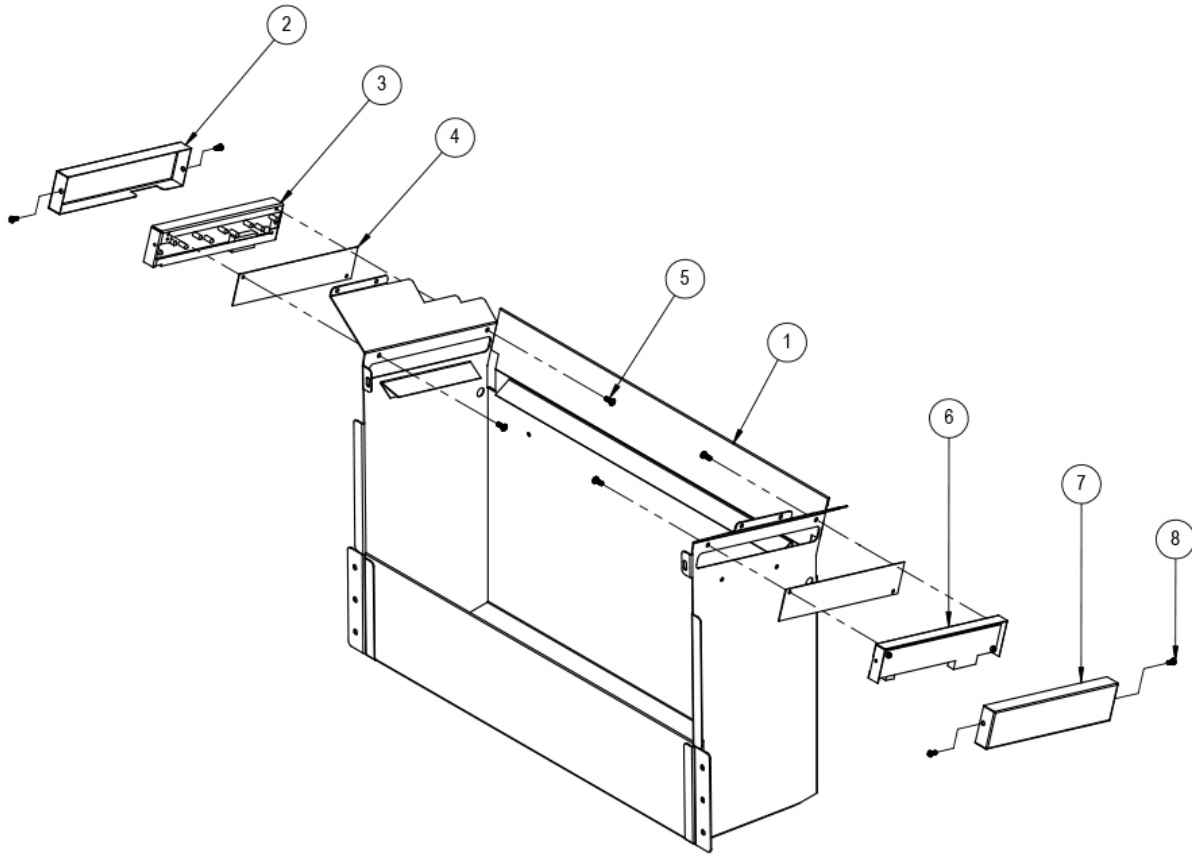

### Parts List

ITEM NO.	PART NO.	DESCRIPTION	QTY.
1	SAI70033A	DELIVERY BIN	1
2	STI84182	COVER SENSOR LEFT	1
3	SAI779	VEND SENSOR ASSEMBLY LEFT	1
4	PLI88001	RED LENS	2
5	FA205	SCREW	4
6	SAI775	VEND SENSOR ASSEMBLY RIGHT	1
7	STI84183	COVER SENSOR RIGHT	1
8	FAI987	SCREW	4

## Ambient Delivery Bin Assembly ENV5S

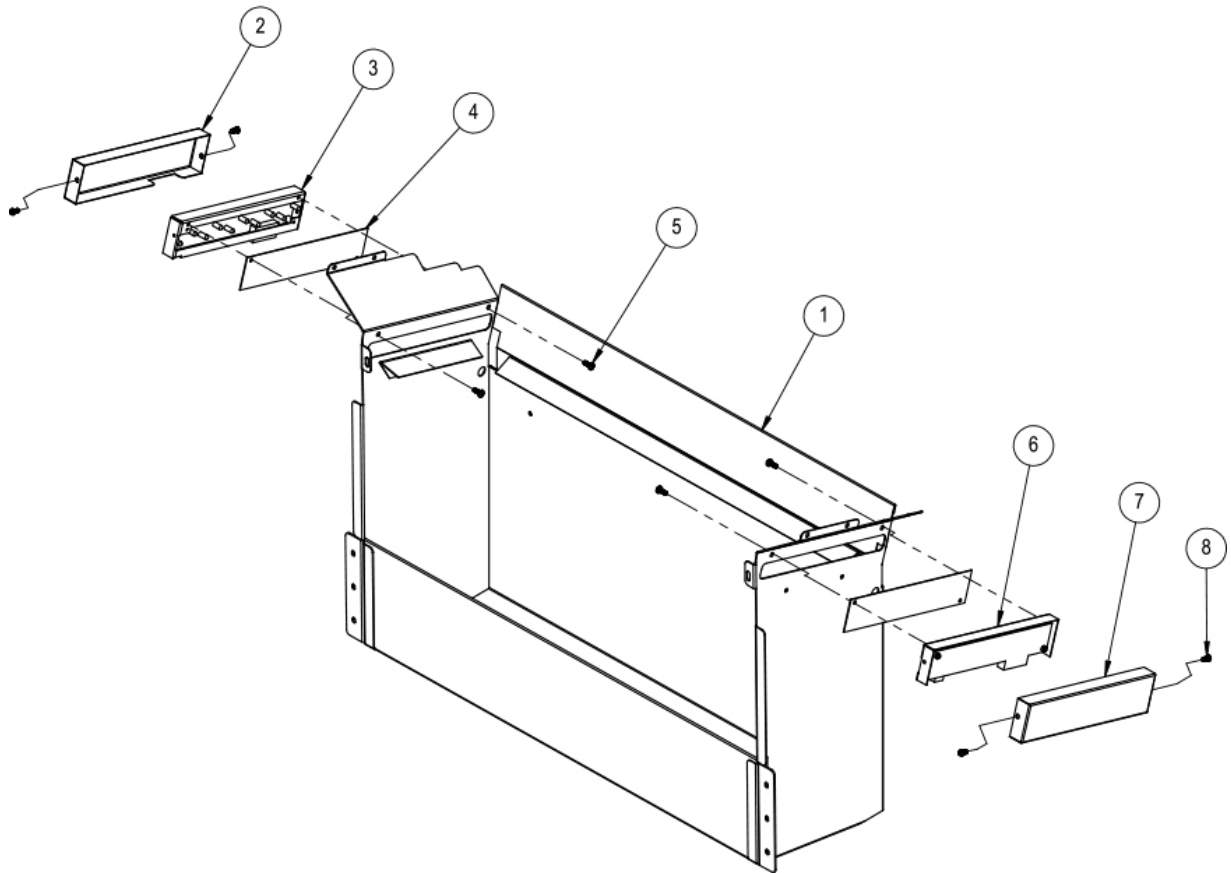

### Parts List

ITEM NO.	PART NO.	DESCRIPTION	QTY.
1	SAI88018	DELIVERY BIN	1
2	STI84182	COVER SENSOR LEFT	1
3	SAI779	VEND SENSOR ASSEMBLY LEFT	1
4	PLI88001	RED LENS	2
5	FA205	SCREW	4
6	SAI775	VEND SENSOR ASSEMBLY RIGHT	1
7	STI84183	COVER SENSOR RIGHT	1
8	FAI987	SCREW	4

## Refrigerated Delivery Bin Assembly ENV5B/ENV5C

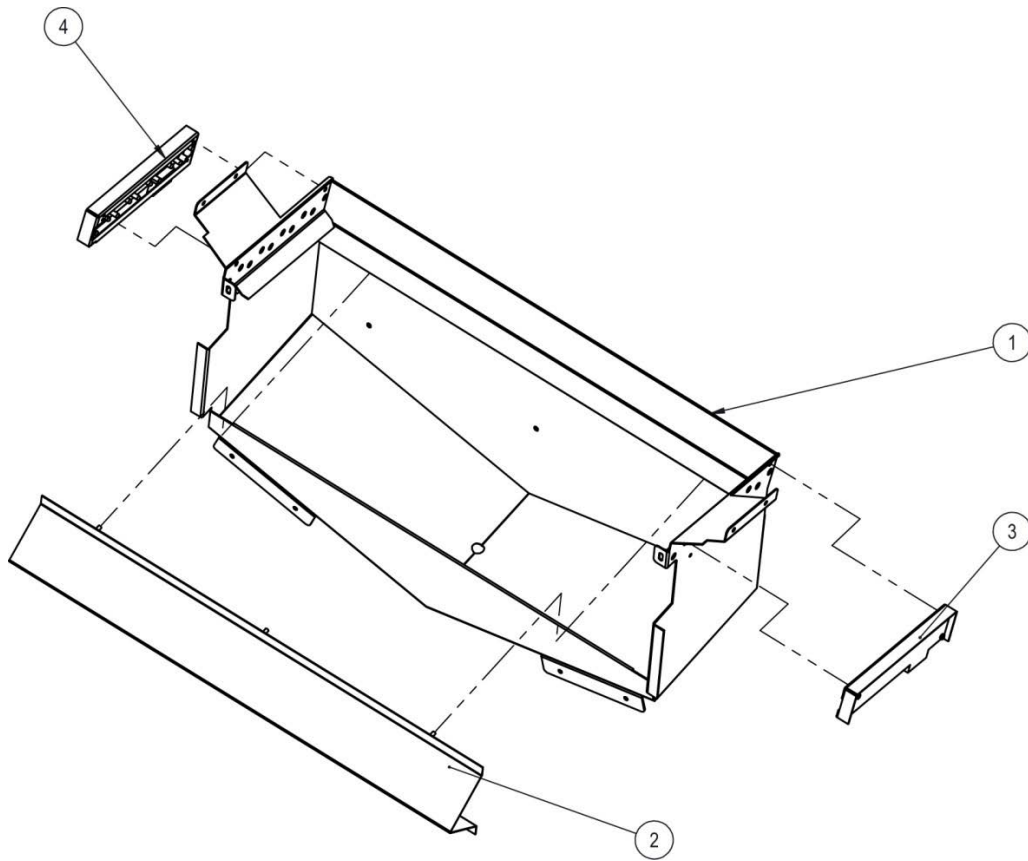

ITEM	PART NO.	DESCRIPTION
1	SAI87016	DELIVERY BIN ASSEMBLY (5-WIDE)
1	SAI58010	DELIVERY BIN ASSEMBLY (4-WIDE)
2	STI87055	ANTI-THEFT BRACKET (5-WIDE)
2	STI58034	ANTI-THEFT BRACKET (4-WIDE)
3	SAI775	VEND SENSOR ASSEMBLY, RIGHT
4	SAI779	VEND SENSOR ASSEMBLY, LEFT

## Electrical Box Assembly ENV5S

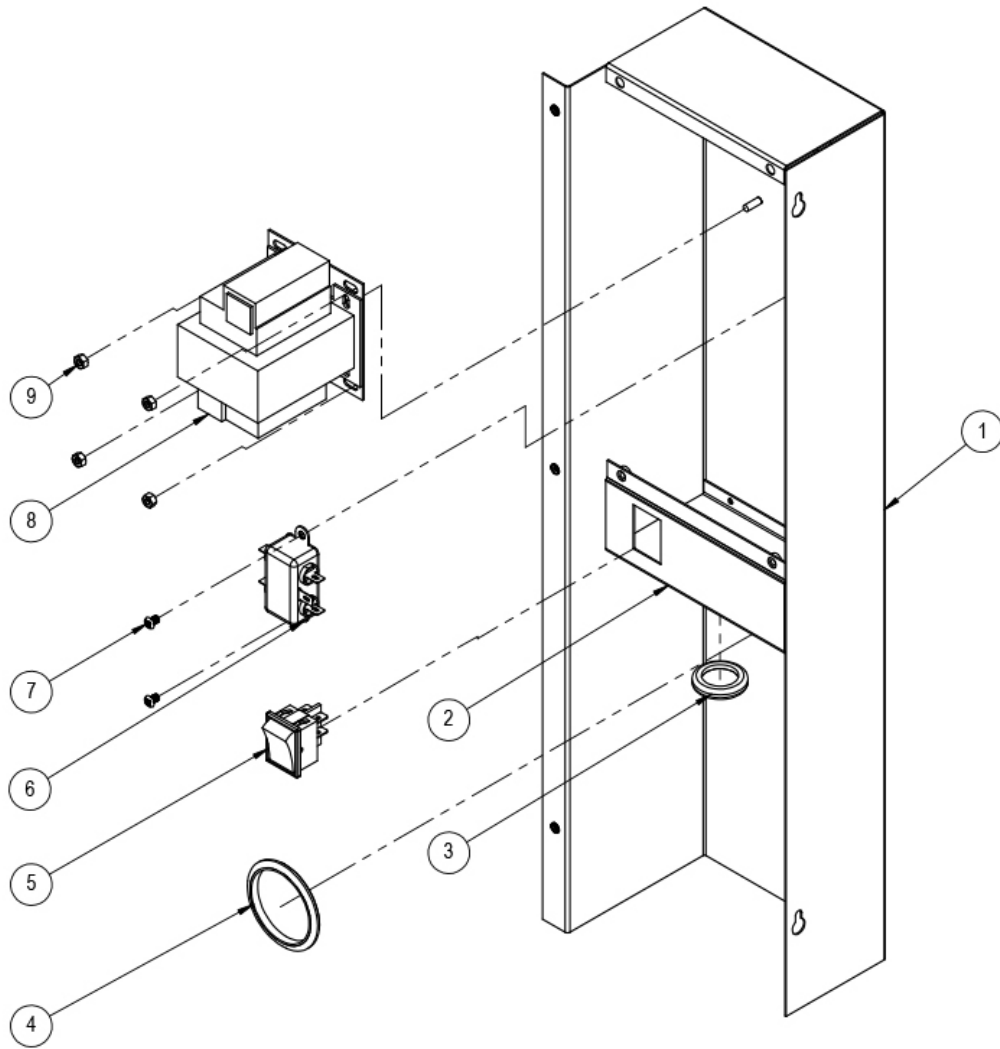

## Parts List

ITEM NO.	PART NO.	DESCRIPTION	QTY.
1	STI70060	BOX ELECTRICAL	1
2	STI70010	BRACKET SWITCH MOUNTING	1
3	HAI741B	GROMMET	1
4	FAI602	GROMMET	1
5	ELI916	SWITCH ON OFF	1
6	ELC946A	FILTER	1
7	FAI892	SCREW	2
8	ELC478	TRANSFORMER	1
9	FAI898	NUT NYLOCK	4

## Electrical Box Assembly ENV5C/5B

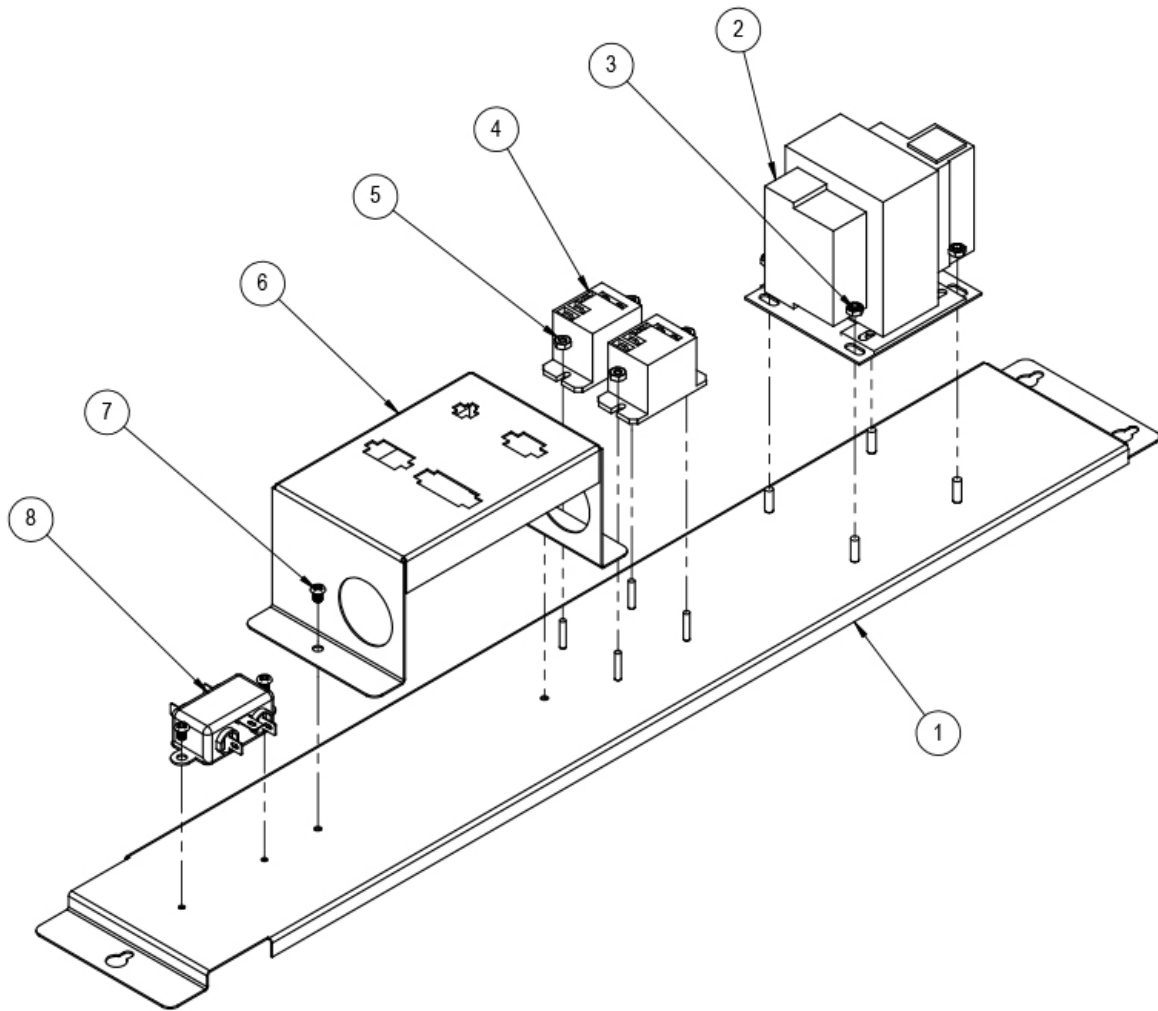

## Parts List

ITEM NO.	PART NO.	DESCRIPTION	QTY.
1	STI87017	PANEL, ELECTRICAL	1
2	ELC478	TRANSFORMER	1
3	FAI898	NUT, NYLOCK	2
4	ELI764	RELAY	2
5	FAI881	HEX NUT	4
6	STI87150	BRACKET, CONNECTOR	1
7	FAI892	SCREW	4
8	ELC946A	FILTER	1



**Vigilant Vend Sensor, Right Side Assembly**

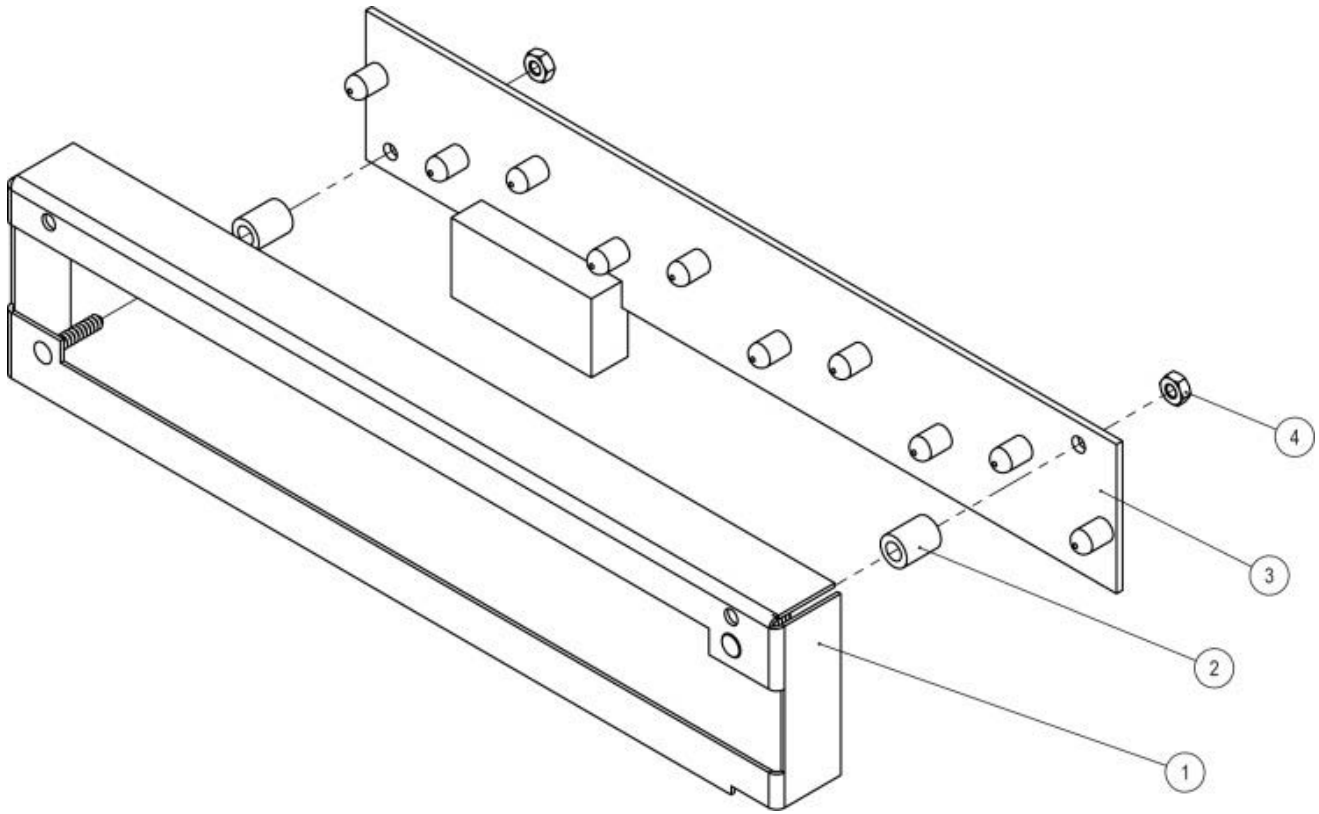

ITEM	PART NO.	DESCRIPTION
1	STI70086	SENSOR BRACKET
2	PLI609A	SPACER
3	ELI974	EMITTER
4	FAI922	NUT

## Vigilant Vend Sensor, Left Side Assembly

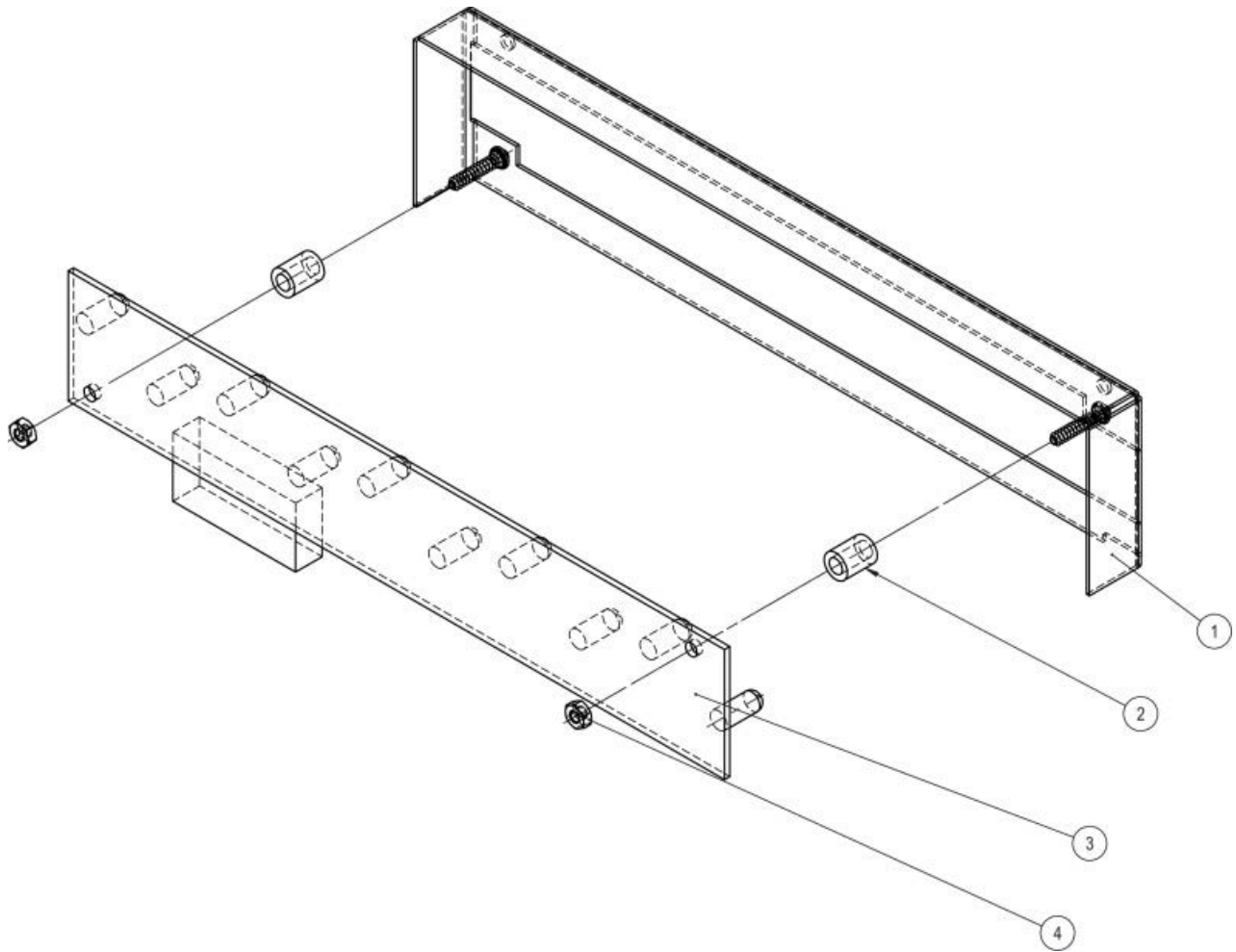

ITEM	PART NO.	DESCRIPTION
1	STI70086	SENSOR BRACKET
2	PLI609A	SPACER
3	ELI2169	DETECTOR
4	FAI922	NUT

## Tray Assemblies

### 8 Space Tray Assembly, Confectionery (Candy)

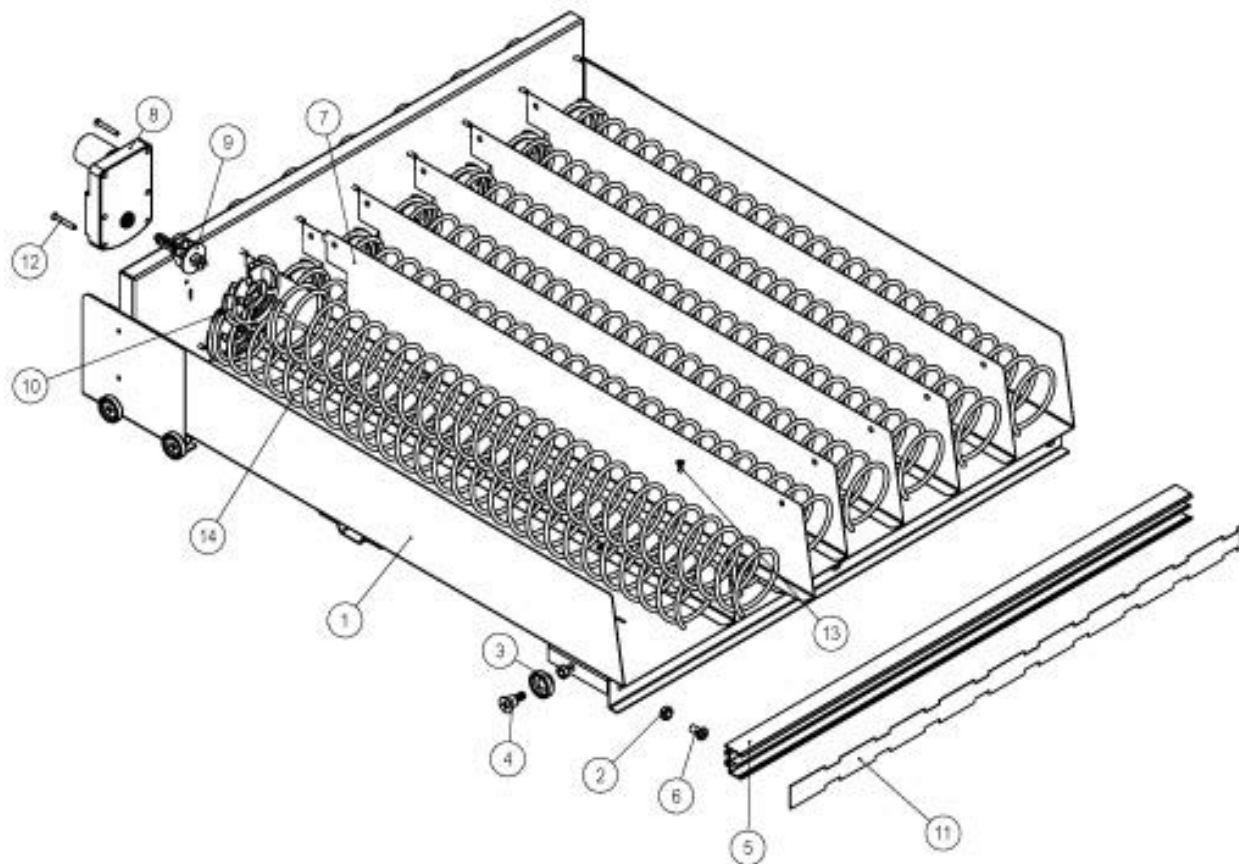

ITEM	PART NO.	DESCRIPTION
1	SAI84024	ASSEMBLY, WELDED TRAY
2	FAI923	NUT, NYLOCK, M6
3	PLI802A	WHEEL, TRAY
4	HAI602	PIN, WHEEL, TRAY
5	PLC958	PROFILE, PRICE SELECTION
6	HAI976	PIN, PROFILE LABEL HOLDING
7	STI70010A	PARTITION, TRAY
8	ELC920	MOTOR
9	PLI721C	SHAFT, GEAR MOTOR
10	PLI331	HUB, COIL, RETAINER
11	PLI84001	STRIP, PRICE SCROLL, HOLDING
12	FAI882	SCREW
13	FAI892	SCREW
14	WFI602	COIL, 18 SPACE, RIGHT
-	WFI552	COIL, 15 SPACE, RIGHT
-	WFI524	COIL, 24 SPACE, RIGHT

## 10 Space Tray Assembly, Confectionery (Candy)

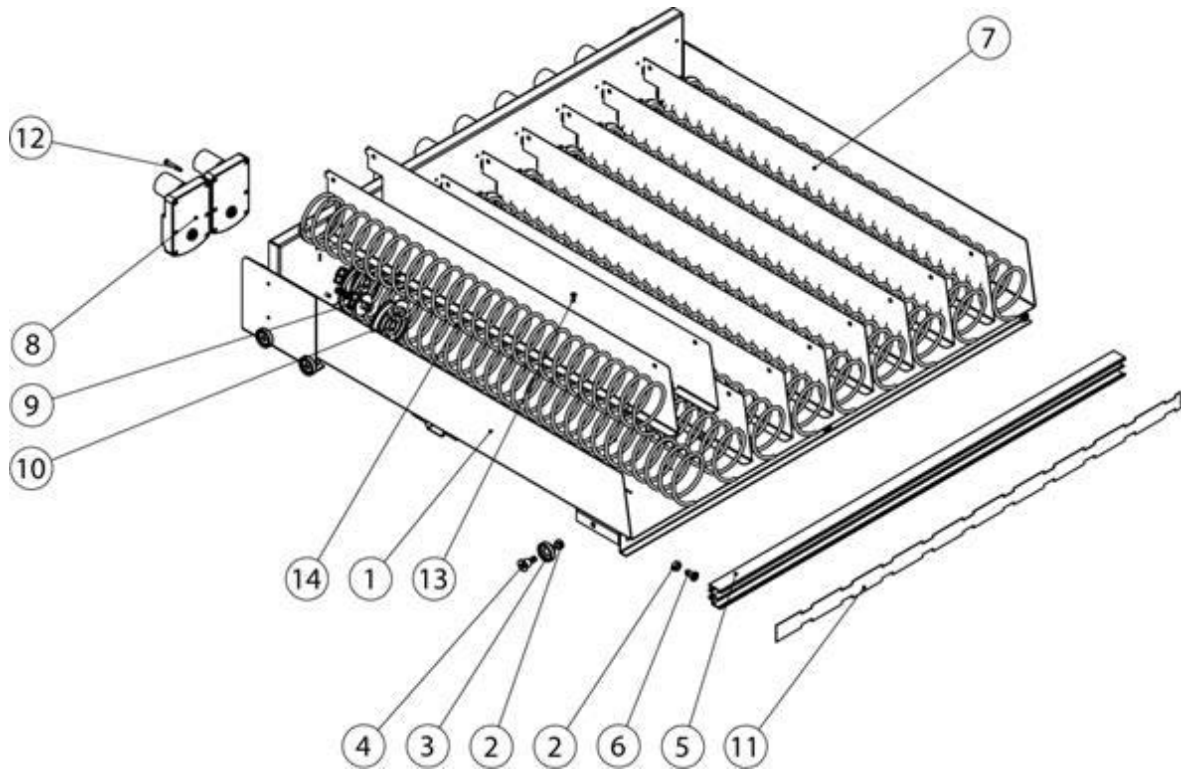

ITEM	PART NO.	DESCRIPTION
1	SAI87041	ASSEMBLY, WELDED TRAY
2	FAI923	NUT, NYLOCK, M6
3	PLI802A	WHEEL, TRAY
4	HAI602	PIN, WHEEL, TRAY
5	PLC958	PROFILE, PRICE SELECTION
6	HAI976	PIN, PROFILE LABEL HOLDING
7	STI70010A	PARTITION, TRAY
8	ELC920	MOTOR
9	PLI721C	SHAFT, GEAR MOTOR
10	PLI331	HUB, COIL, RETAINER
11	PLI87001	STRIP, PRICE SCROLL, HOLDING
12	FAI882	SCREW
13	FAI892	SCREW
14	WFI602	COIL, 18 SPACE, RIGHT
-	WFI552	COIL, 15 SPACE, RIGHT
-	WFI524	COIL, 24 SPACE, RIGHT

### 4 Space Tray Assembly, Snack Dual Coil

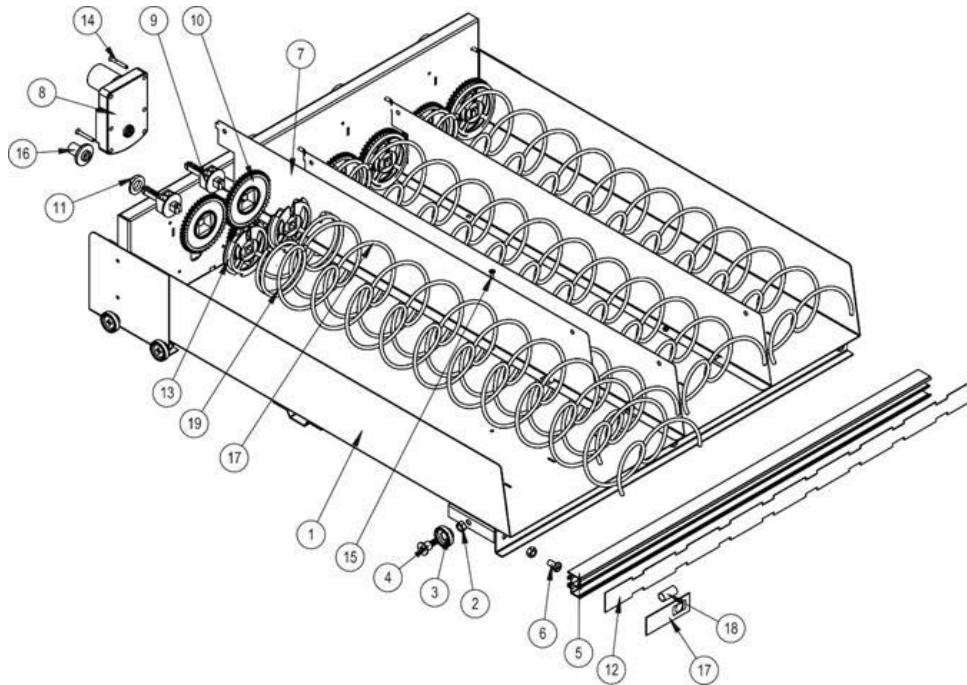

ITEM	PART NO.	DESCRIPTION
1	SAI84024	ASSEMBLY, WELDED TRAY
2	FAI923	NUT, NYLOCK
3	PLI802A	WHEEL, TRAY
4	HAI602	PIN, WHEEL, TRAY
5	PLC958	PROFILE, PRICE SELECTION
6	HAI976	PIN, PROFILE LABEL HOLDING
7	STI70010A	PARTITION, TRAY
8	ELC920	MOTOR
9	PLI721C	SHAFT, GEAR MOTOR
10	PLI536	GEAR
11	PLI332A	BUSHING, DUAL COIL
12	PLI84001	STRIP, PRICE SCROLL, HOLDING
13	PLI331	HUB, COIL, RETAINER
14	FAI932	SCREW
15	FAI892	SCREW
16	PLI336c	RETAINER SLEEVE, GEAR
17	DEI315B	SELECTION
18	DE140	PRICE SCROLL
19	WFI548	COIL, 10 SPACE, LEFT
-	WFI549	COIL, 10 SPACE, RIGHT
-	WFI568	COIL, 12 SPACE, LEFT
-	WFI59	COIL, 12 SPACE, RIGHT

## 5 Space Tray Assembly, Snack Dual Coil

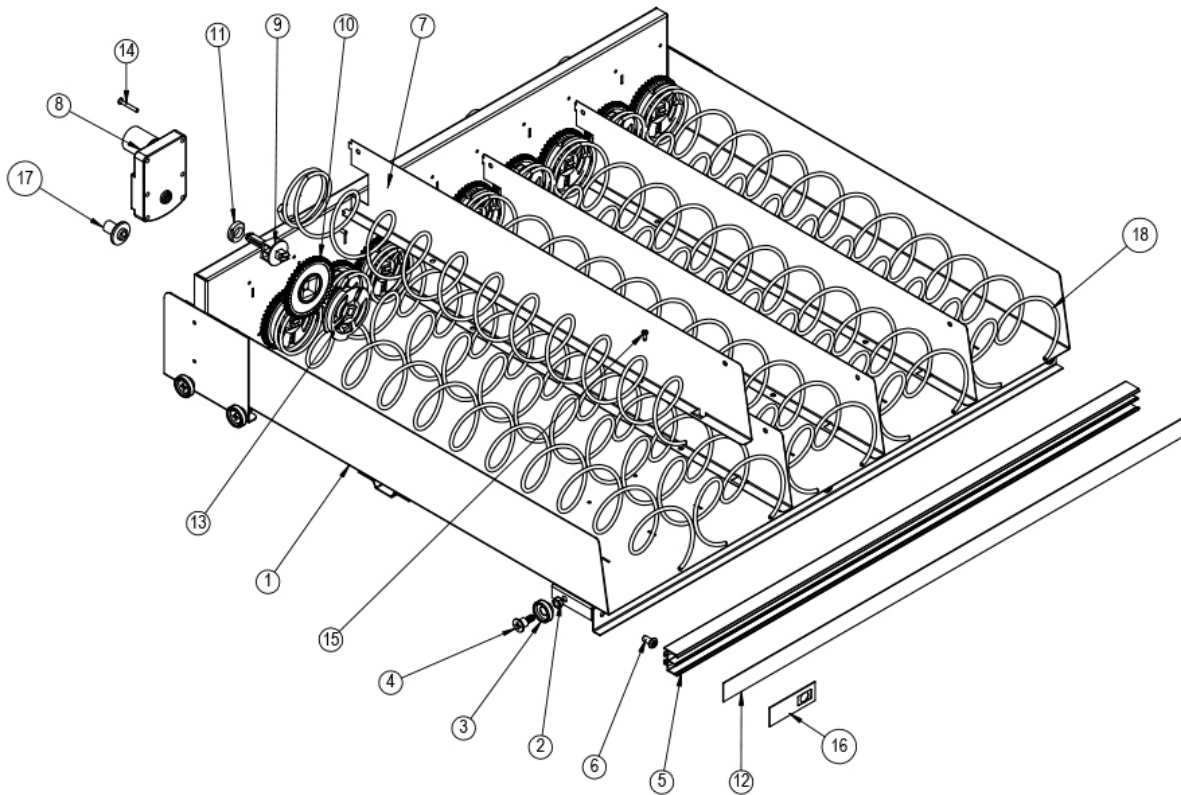

### Parts List

ITEM NO.	PART NO.	DESCRIPTION	QTY.
1	SAI87041	TRAY, WELDED	1
2	FAI923	NUT	9
3	PLI802A	WHEEL	6
4	HAI602	PIN	6
5	PLC958	PRICE & SELECTION PROFILE	1
6	HAI976	PIN	3
7	STI70010A	DIVIDER	4
8	ELC920/ELC925	MOTOR (ELC925 FOR REFRIGETED)	5
9	PLI721C	SHAFT	10
10	PLI536	GEAR	10
11	PLI332A	BUSH, RETAINER	10
12	PLI89001	STRIP, PRICE SCROLL	1
13	PLI331	COIL RETAINER	10
14	HA539	SCREW	10
15	FA605	SCREW	4
16	DEI315B	SELECTION DECAL	1
17	PLI336C	RETAINER SLEEVE	5
18	WFI548	COIL, 10 SPACE, LEFT	5
-	WFI549	COIL, 10 SPACE, RIGHT	5

### 7 Space Tray Assembly, Beverage

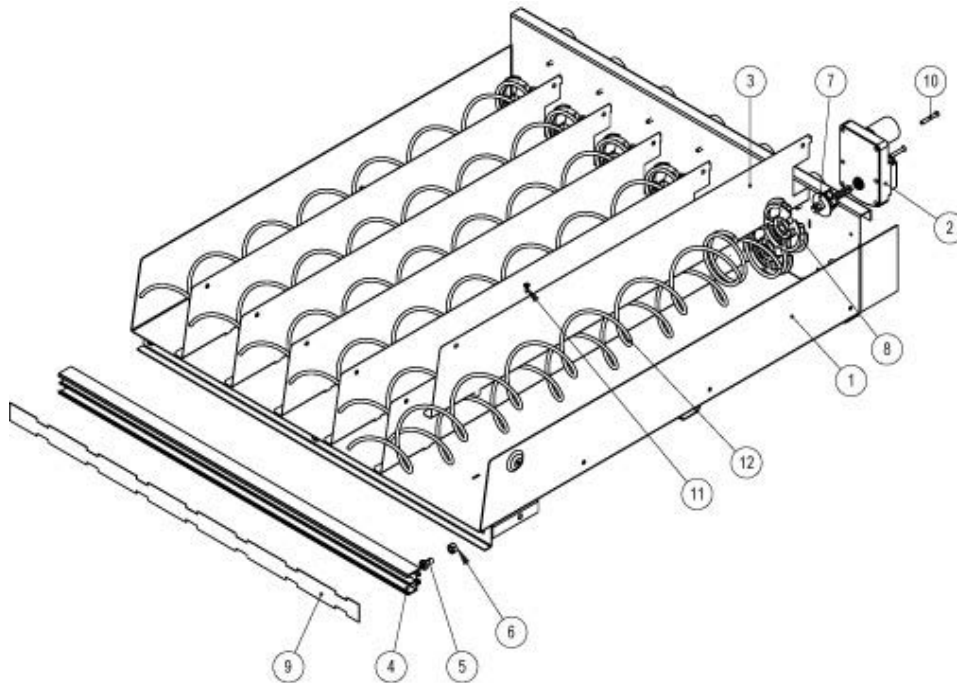

ITEM	PART NO.	DESCRIPTION
1	SAI84028	ASSEMBLY, WELDED TRAY, 7-SELECTION
2	ELC925	MOTOR
3	STI70010A	PARTITION, TRAY
4	PLC958	PROFILE, PRICE SELECTION
5	HAI976	PIN, PROFILE LABEL HOLDING
6	FAI923	NUT, NYLOCK
7	PLI721C	SHAFT, GEAR MOTOR
8	PLI331	HUB, COIL, RETAINER
9	PLI84002	STRIP, PRICE SCROLL, HOLDING FOR 7 SELECTION TRAY
10	FAI882	SCREW
11	FAI892	SCREW
12	WFI576	COIL, 6 SPACE, RIGHT

## 8 Space Tray Assembly, Beverage

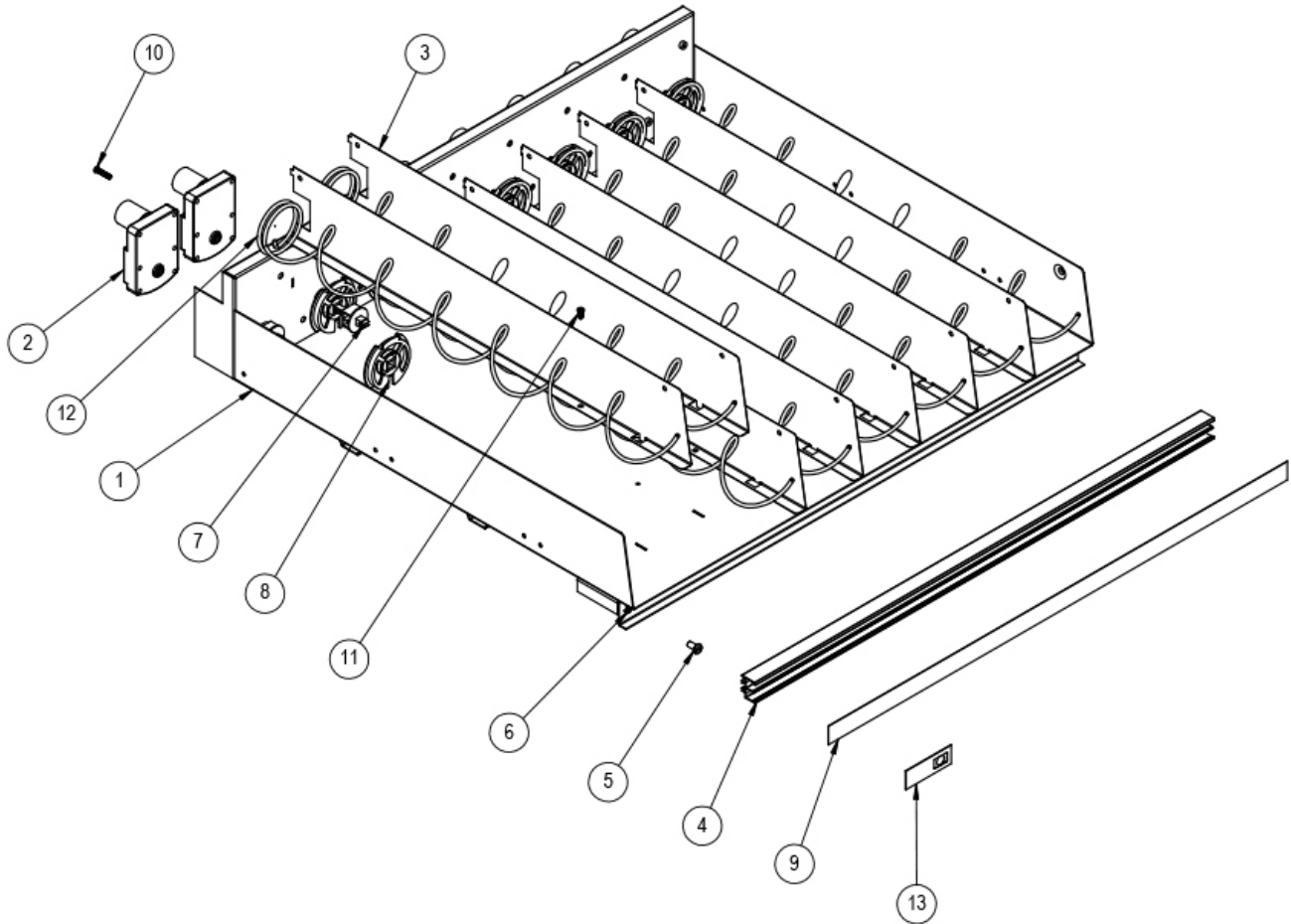

## Parts List

ITEM NO.	PART NO.	DESCRIPTION	QTY.
1	SAI87040	TRAY, WELDED	1
2	ELC925	MOTOR	8
3	STI70010A	DIVIDER	7
4	PLC958	PRICE & SELECTION PROFILE	1
5	HAI976	PIN	3
6	FAI923	NUT	3
7	PLI721C	SHAFT	8
8	PLI331	COIL RETAINER	8
9	PLI87001A	STRIP, PRICE SCROLL	1
10	HA539	SCREW	16
11	FA605	SCREW	7
12	WFI576	COIL, 6 SPACE, RH	8
13	DEI315B	SELECTION DECAL	1



## 10 Space Tray Assembly

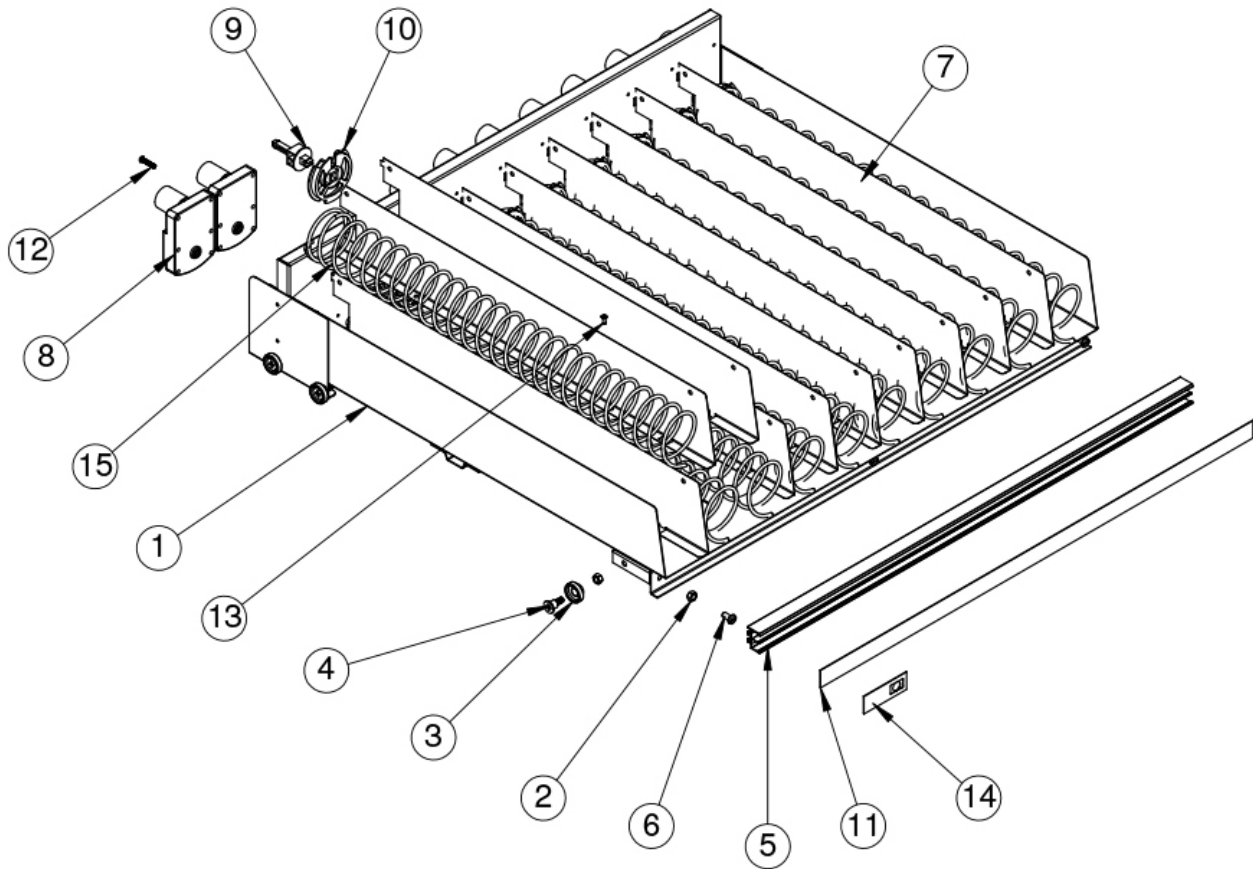

## Parts List

ITEM NO.	PART NO.	DESCRIPTION	QTY.
1	SAI87041	TRAY, WELDED	1
2	FAI923	NUT	9
3	PLI802A	WHEEL	6
4	HAI602	PIN	6
5	PLC958	PRICE & SELECTION PROFILE	1
6	HAI976	PIN	3
7	STI70010A	DIVIDER	9
8	ELC920/ELC925	MOTOR (ELC925 FOR REFRIGATED)	10
9	PLI721C	SHAFT	10
10	PLI331	COIL RETAINER	10
11	PLI89001	STRIP, PRICE SCROLL	1
12	HA539	SCREW	20
13	FA605	SCREW	9
14	DEI315B	SELECTION DECAL	1
15	WFI602	COIL, 18 SPACE RH	3
-	WFI549	COIL, 10 SPACE RH	3
-	WFI569	COIL, 12 SPACE RH	4

## **LIMITED WARRANTY**

Seaga warrants to the original purchaser that the equipment is free from defects in material and factory workmanship for a period of one (1) year from date of shipment.

This warranty applies only if the equipment has been serviced and maintained in strict accordance with the instructions presented in the Operator's Manual and no unauthorized service, repair, alteration or disassembly has been performed. Any defects caused by improper power source, poor water quality or pressure, an installed water filtration system not fully functioning, abuse of the product, accident, alteration, vandalism, improper service and maintenance schedules, neglecting to de-scale and sanitize on a regular basis, use of products or ingredients not allowed in the machine, corrosion due to use of non-approved detergents or cleaning solutions, or damage incurred during return shipment will not be covered by this warranty. Further, equipment that has had the serial number removed, altered or otherwise defaced will not be covered by this warranty.

Lighting components, refrigerant, glass, paint, decals, fuses, filters or hygiene replacement parts, labor and/or installation are not covered by this warranty.

Follow proper maintenance procedures and use of equipment, as described in the Operator's Manual provided on Seaga's web site at [seaga.com](http://seaga.com), which include but are not limited to:

- Cleaning of equipment including regular maintenance
- Proper installation and location of equipment with respect for the indicated temperature and humidity levels
- Proper use of equipment including loading, programming and setup

**THIS WARRANTY IS EXCLUSIVE AND IS GIVEN BY SEAGA AND ACCEPTED BY BUYER IN LIEU OF ANY AND ALL OTHER WARRANTIES, WHETHER EXPRESS OR IMPLIED, INCLUDING, WITHOUT LIMITATION, ALL WARRANTIES OF MERCHANTABILITY AND FITNESS FOR A PARTICULAR PURPOSE. ALL SUCH OTHER WARRANTIES ARE HEREBY EXPRESSLY DISCLAIMED BY SEAGA AND WAIVED BY BUYER. Seaga neither assumes nor authorizes any person to assume for it any obligation or liability in connection with the sale of said unit(s) or any part(s) thereof.**

Repair or replacement of proven defective parts is limited to manufacturing defects demonstrated under normal use and service during warranty period. Contact Seaga's Customer Care Department to be assigned a Return Authorization (RA) number. Seaga requires complete information including the serial number(s) of the machine(s), date of purchase and description of the part and/or suspected defect. Seaga may also be contacted, with complete information, by phone: 815.297.9500, by fax: 815.297.1700 and also by email: [customercare@seaga.com](mailto:customercare@seaga.com)

**Send defective part(s), assembly or complete unit, Attention to the RA Number, prepaid or delivered to:**



**700 Seaga Drive  
Freeport IL 61032**

Seaga will repair or replace, at our option, any covered part which meets the provisions herein during the warranty period. It is our discretion to replace defective parts with comparable parts. Seaga reserves the right to make changes or improvements in its products without notice and without obligation, and without being required to make corresponding changes or improvements in equipment already manufactured or sold.