

# **FUTURA**

**COMBO VENDOR**

**MODEL 3589**

**SERVICE MANUAL**

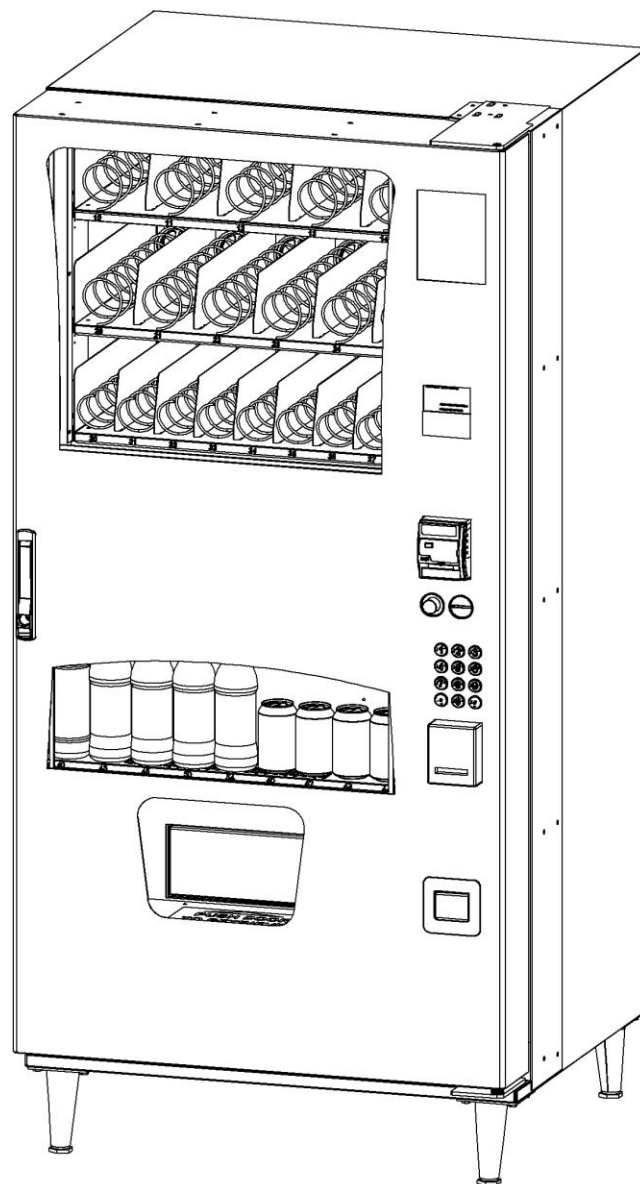

# TABLE OF CONTENTS

<b>INTRODUCTION.....</b>	<b>2</b>	"MAKE ANOTHER SELECTION" LED OPERATION.....	9	POS MESSAGE.....	15
<b>SPECIFICATIONS.....</b>	<b>3</b>	VEND CYCLE.....	10	TEMPERATURE SETPOINT.....	15
<b>VENDOR SET UP.....</b>	<b>4</b>	CHANGE RETURN.....	10	CONFIGURATION MENU.....	16
UNPACKING.....	4	<b>DEX CAPABILITY (OPTION).....</b>	<b>10</b>	VENDOR CONFIGURATION.....	16
INSTALLATION.....	4	<b>BEVERAGE AREA OPERATION.....</b>	<b>11</b>	VENDOR SPACE-TO-SALES.....	16
GROUNDING (EARTHING) & ELECTRICAL.....	4	SOLD OUT VEND SEQUENCE.....	11	PRICING.....	17
COMPONENT LOCATION.....	5	<b>SERVICE MODE.....</b>	<b>12</b>	PRICE ALL SELECTIONS.....	17
REFRIGERATION OPERATION.....	6	SERVICE MODE BUTTTON.....	12	PRICE BY ROW / TRAY.....	17
CARD READER ACCESS.....	6	KEYPAD OPERATION.....	12	PRICE BY SELECTION.....	17
LOADING SNACK PRODUCTS.....	7	<b>PROGRAMMING.....</b>	<b>12</b>	SET COUPON VALUE.....	18
SPIRAL AND TRAY ADJUSTMENT.....	7	TUBE FILL AND DISPENSE COINS MODES.....	12	SET TOKEN VALUE.....	18
SPIRAL TIMING.....	7	MOTOR COUNT MODE.....	13	ACCOUNTING MODE.....	19
PRODUCT PUSHERS.....	7	OPTIONS MENU.....	13	ADVANCED OPTIONS.....	21
LOADING BEVERAGE PRODUCTS.....	8	FORCE VEND OPTION.....	13	TEST VEND SELECTION MODE.....	21
LOADING COIN MECHANISM.....	9	BILL ESCROW OPTION.....	13	TEST VEND ALL SELECTIONS MODE.....	21
BILL VALIDATOR OPERATION (OPTIONAL).....	9	MULTI VEND OPTION.....	14	DIAGNOSTICS MODE.....	22
<b>SALES MODE.....</b>	<b>9</b>	FREE VEND OPTION.....	14	<b>PREVENTATIVE MAINTENANCE.....</b>	<b>25</b>
DISPLAY CREDIT - ELECTRONIC PRICING.....	9	FAST CHANGE.....	14	<b>PARTS ORDERING PROCEDURE.....</b>	<b>25</b>
"USE EXACT CHANGE" LED OPERATION.....	9	OPTICS OPTION.....	15	<b>BEFORE CALLING FOR SERVICE.....</b>	<b>25</b>

The Model and Serial numbers are needed for you to obtain quick service and parts information for your vendor. The numbers are given on the identification plate located on the back of the vendor. Write them into the spaces below for your records.

MODEL NUMBER: \_\_\_\_\_

SERIAL NUMBER: \_\_\_\_\_

## INTRODUCTION

This manual contains instructions, service and installation guidelines for the **Futura Combo Vendor**. The **Futura Combo Vendor** is designed as a combination snack and beverage merchandiser. The vendor is capable of dispensing a wide variety of snacks and beverages.

The **Futura Combo Vendor** is equipped with an electronic control system. All vending functions, pricing, and features are programmed through the controller. Changes can be made without any additional accessories or remote parts.

Selections can be priced individually from \$.05 to \$99.95 in five cent increments (US currency).

Accountability mode records Total Cash and Credit transactions and Total Vend cycles performed by the vendor. Information for individual selections, complete rows or total vendor can be compiled and used for inventory and ordering records.

Control System malfunctions are recorded and displayed when the vendor is placed in Service Mode. Non-functioning motors or selections are indicated. Each selection has an individual motor. When one selection motor fails the other selections are unaffected and will continue working.

The vending sequence is "first-in, first-out" for each selection, eliminating the need for stock rotation to ensure product freshness.

Read this manual thoroughly. Become familiar with the vendor's components and features. The initial setup of a vendor is a very important step towards insuring that the equipment operates trouble-free. Carefully follow the instructions for the initial installation of the vendor to avoid service problems and minimize setup time.

Access to the service area of this vendor should be permitted only to individuals having knowledge and practical experience in vendor setup and loading, especially in areas of safety and hygiene.

**If you have questions concerning the information in the manual, replacement parts, or the operation of the vendor, note your machine's Model and Serial Numbers before contacting:**

VendNet™  
 165 North 10th Street  
 Waukee, Iowa 50263 - USA  
 Parts: (888) 259-9965  
 Service: (800) 833-4411  
 Parts Fax: 515-987-4447  
 All Other: (888) 836-3638  
 E-Mail: Vendnet@vendnetusa.com

# SPECIFICATIONS

## DIMENSIONS

<b>Width</b>	34.5 inches (876mm)
<b>Height</b>	74.5 inches (1892mm)
<b>Depth</b>	31 7/32 inches (793) mm
<b>Weight / Shipping Weight</b>	551 lbs. (254kg) / 600 lbs. (272kg)
<b>Snack Window Size (tempered glass only)</b>	22 17/32" X 25 1/4" X 1/8" Thick (626mm X 641mm X 3mm)
<b>Live Display Window Size (tempered glass only)</b>	9 1/4" X 25 1/4" X 1/8" Thick (235mm X 641mm X 3mm)

## STANDARD SNACK TRAY CONFIGURATION (MAY VARY)

<b>Trays</b>	3
<b>Total Selections</b>	20
<b>Snack Selections</b>	5
<b>Medium Snack Selections</b>	6
<b>Candy Selections</b>	9
<b>Standard Capacity (may vary)</b>	225

## STANDARD BEVERAGE TRAY CONFIGURATION (MAY VARY)

<b>Live Display Selections</b>	9
<b>Live Display Can Selections</b>	4
<b>Can Capacity</b>	80
<b>Live Display Bottle Selections</b>	5
<b>Bottle Capacity</b>	56
<b>Pre-Cool Area</b>	10 (12oz. Cans)
<b>Total Beverage Capacity (may vary)</b>	136

## ELECTRICAL

<b>Voltage</b>	120 VAC	240 VAC
<b>Cycle</b>	60 Hz	50 Hz
<b>Amperage</b>	2.5A/300W	1.25A/300W
<b>Transformer</b>	120 VAC to 24 VAC	240 VAC to 24 VAC

## COINAGE (NOTE: DOLLAR BILL VALIDATOR AND/OR CARD READER IS OPTIONAL)

<b>MDB Version</b>	Industry Standard MDB Coin Mechanisms, Bill Validators and Card Readers (OPTIONALLY EQUIPPED)
<b>International</b>	
<b>Domestic</b>	

## VENDOR OPERATION

<b>Location</b>	Suitable for indoor use only. This appliance is not suitable for installation in an area where a water jet could be used.
<b>Sound Level</b>	Produces less than 70 dBA during normal operation.
<b>Recommended Operating Temperature</b>	Between 32° and 100° F° (0° and 37.8° Celsius)

# VENDOR SET UP

## UNPACKING

This vendor was thoroughly inspected before leaving the factory and the delivering carrier has accepted responsibility for this vendor. Note any damage or irregularities at the time of delivery and report them to the carrier. Request a written inspection report from the claims inspector to file any claim for damage. File the claim with the carrier (not the manufacturer) within 15 days after receipt of the vendor.

**NOTE:** If the power supply cord is damaged, it must be replaced by the manufacturer, its service agent, or similarly qualified individual in order to avoid hazard.

**CAREFULLY REMOVE THE OUTSIDE PACKING MATERIAL BEING CAREFUL NOT TO DAMAGE THE VENDOR'S FINISH OR EXTERIOR. INSPECT THE VENDOR FOR CONCEALED SHIPPING DAMAGE. REPORT ANY DAMAGE HIDDEN BY THE SHIPPING MATERIAL DIRECTLY TO THE DELIVERING CARRIER ON A HIDDEN DAMAGE REPORT.**

## INSTALLATION

Position the vendor in its place of operation. Make sure to level the vendor by placing a bubble level on the top of the machine and adjusting the vendor leg levelers. Position the vendor so the power cord easily reaches the power outlet or receptacle (DO NOT USE AN EXTENSION CORD). Check that the door will open fully without interference.

**NOTICE:** The vendor must be level and there must be a minimum of 4" between the back of the vendor and the wall for proper air flow.

Retrieve the vendor keys from the coin return cup. Open outer door and remove all internal packing material.

## GROUNDING (EARTHING) & ELECTRICAL

**NOTE: SEE SAFETY MANUAL**

Consult local, state, and federal codes and regulations before installing the vendor.

Refer to the Safety Installation Guidelines document found in the service package shipped with your vendor.

Before connecting the vendor, the integrity of the main electrical supply must be checked for correct polarity, presence of ground (earth) and correct voltage. These checks should be repeated at six-month intervals with the routine safety electrical testing of the vendor itself.

If the receptacle is not properly grounded or polarized, contact a licensed electrician to correctly polarize and/or ground the receptacle to ensure safe operation.

For proper operation of any equipment utilizing electronically controlled components, the equipment should be placed on an isolated, or dedicated, noise-free circuit properly polarized and grounded. Use of a surge suppressor is recommended for locations where electrical noise is present.

**After** all set up has been completed turn on the Power Switch (see Component Locations diagram later in manual).

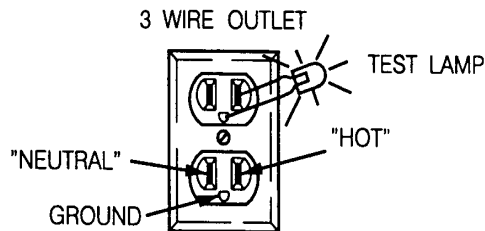

**INSIDE VIEW - DOOR SHOWN OPEN**

**COMPONENT LOCATIONS**

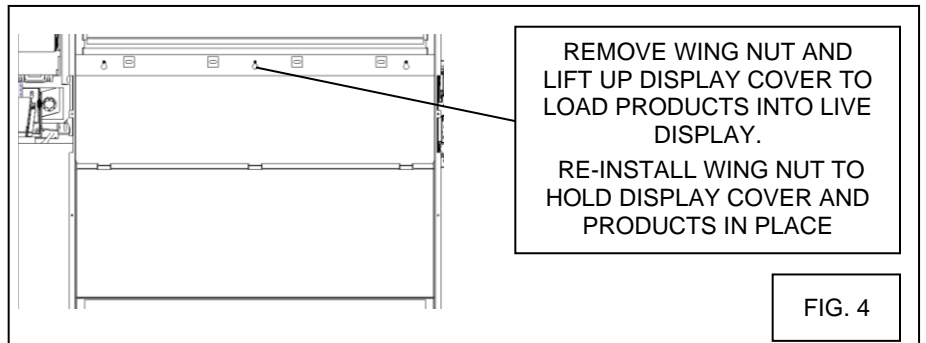
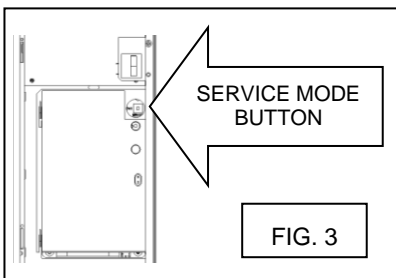
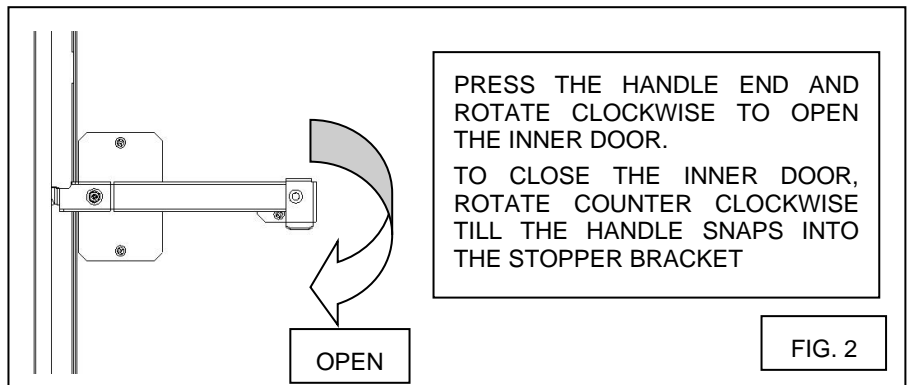
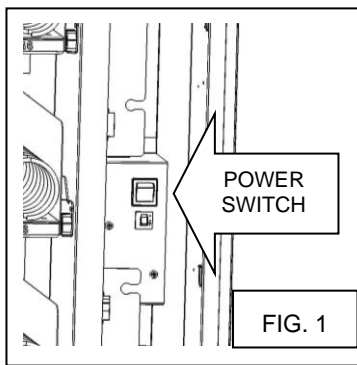
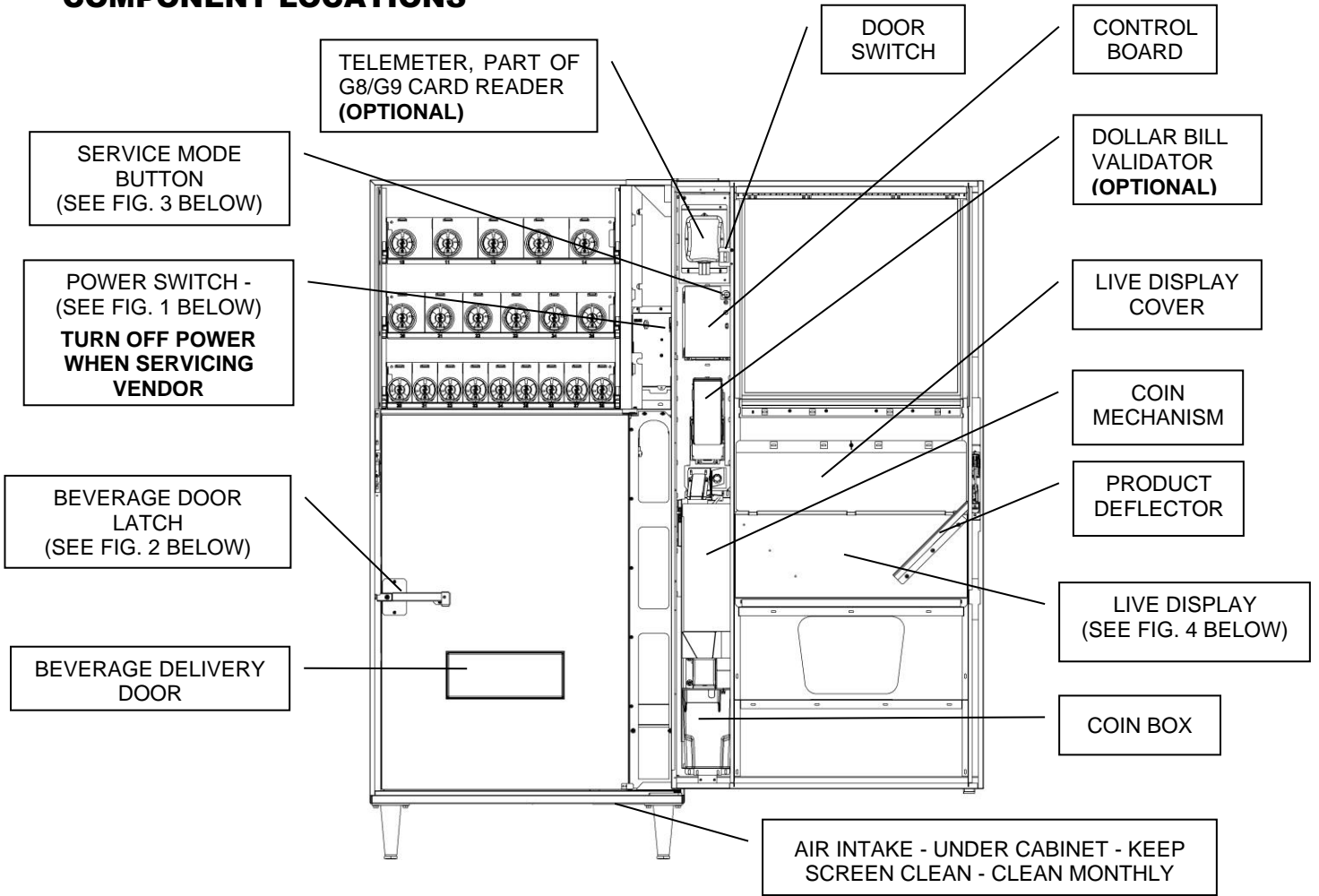

## REFRIGERATION OPERATION

The Vendor's refrigeration system will operate trouble-free for many years and with highest efficiency with proper operation and maintenance. It is critical that the machine be positioned with a minimum of a 4" space between the back of the machine and the wall. Also, it is critical that the bottom screen and refrigeration compartment be kept clean. Clean/vacuum the screen under the cabinet monthly.

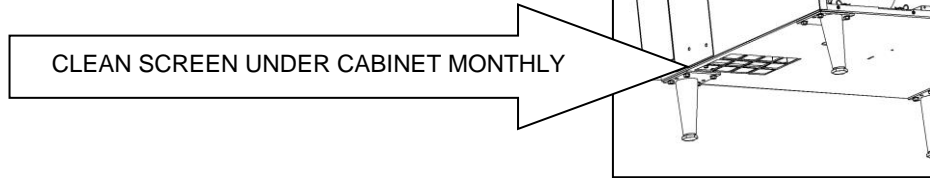

**NOTICE:** There must be a minimum of 4" between the back of the vendor and the wall for proper air flow.

**NOTICE:** DO NOT MAKE LARGE ADJUSTMENTS TO THE FACTORY TEMPERATURE SETTING. DOING SO MAY RESULT IN A FREEZ UP OF THE EVAPORATOR COIL AND/OR BEVERAGES. PROLONGED FREEZE UPS WILL CAUSE THE REFRIGERATION TO OVERHEAT AND MAY CAUSE PERMANENT DAMAGE TO THE SYSTEM.

## CARD READER ACCESS

Please follow below steps to access the Card Reader.

1. Turn OFF power to the machine and then unplug the coin mech harness.
2. Remove coin chute by unscrewing 2 X #6-20 screws. (This step is required to access #8 nuts for next step). See FIG. 1
3. Keeping the coin mech on coin mech mount bracket, unscrew 2 X #8-32 nuts at the top and 2 X #8 screws at the bottom of coin mech mount bracket. See FIG 2 & 3.
4. Remove coin mech mount bracket to access the Card Reader. See FIG. 4

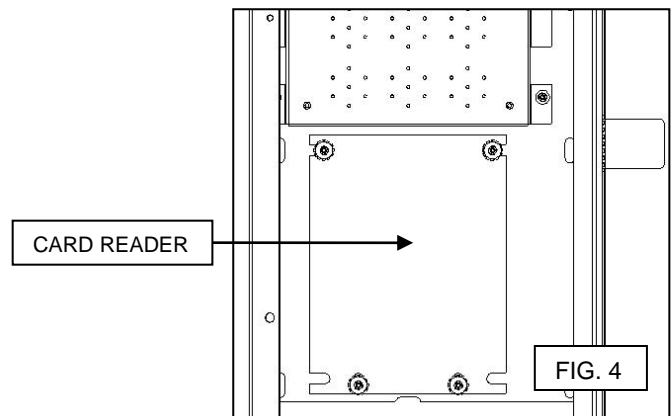
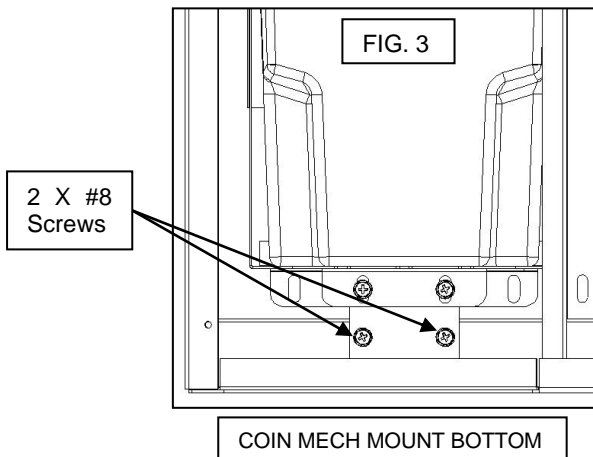
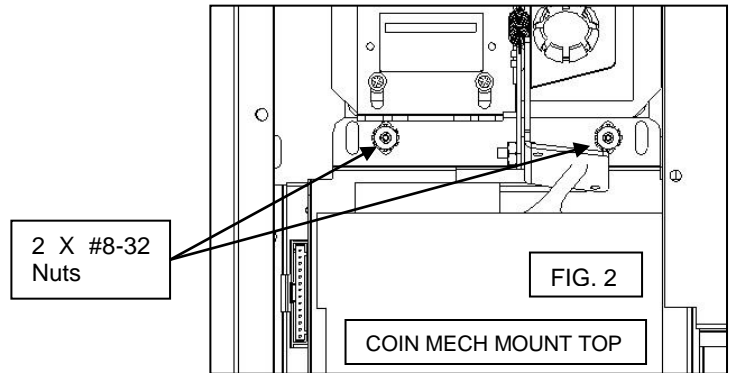
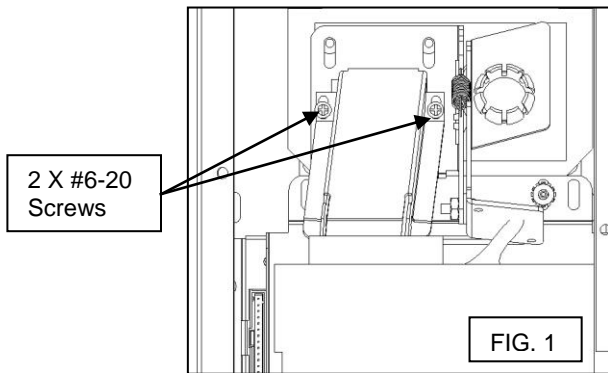

## LOADING SNACK PRODUCTS

Lift the tray up slightly and pull forward until the tray stops then tilt down for ease of loading.

Load product from front to back making sure all items fit freely between the spirals. Do not attempt to force oversized products or packages into the spaces. Do not skip a space. Place the product on the bottom of the compartment on the spirals with the labels facing the front of the vendor for easy identification by the customer.

To vend properly the product must be wider and taller than the diameter of the spiral being used. Undersized products may cause vend problems.

## SPIRAL AND TRAY ADJUSTMENT

The shape, size and thickness of a product affect how well it falls off the tray. Most products can be vended successfully when the spiral end is positioned at 6 o'clock. If vending problems occur with spiral ends at the standard 6 o'clock position, adjust the drop-off either by retiming the spiral or installing a Product Pusher.

### SPIRAL TIMING

Each spiral can be rotated in 45° (degree) increments for a different drop-off point. Most products can be vended successfully when the spiral end is positioned at the position of 6 o'clock.

The general rule is:

**The narrower the product, the higher the timing.**

- Thick Products - 4-6 o'clock
- Most products – 6 o'clock
- Thin Products - 6-8 o'clock

To change the spiral end position:

1. Remove the tray to have access to the back of the motors.
2. Pinch the snap tabs of the spiral coupling and push out until it separates from the motor.
3. Rotate the spiral to the desired position and reinsert the spiral coupling into the motor.
4. Make sure the spiral coupling snaps fully into the motor as shown.
5. Replace the tray and test vend the selection to make sure product vends correctly.

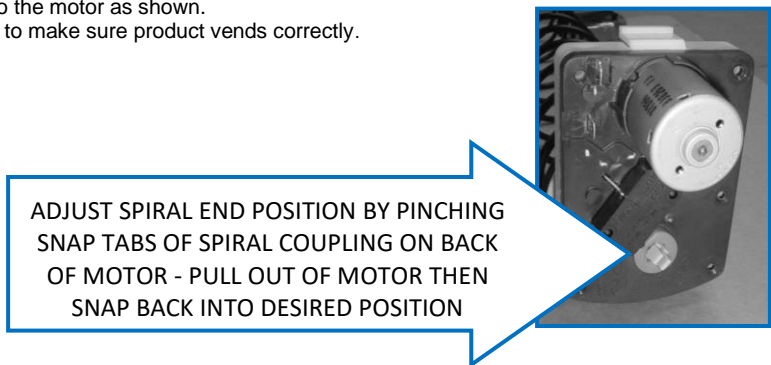
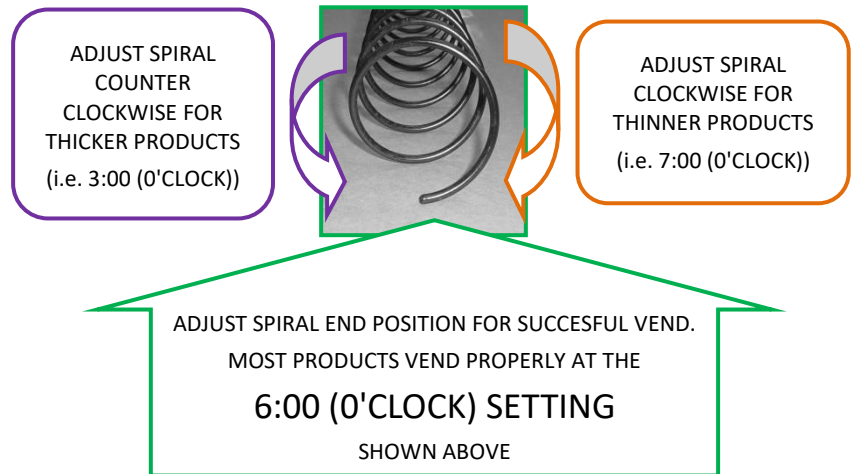

## PRODUCT PUSHERS

If the product still will not vend properly after re-timing of the spiral then install a Product Pusher. The Product Pushers are provided in the service package of the vendor. Snap onto spirals only as necessary as shown.

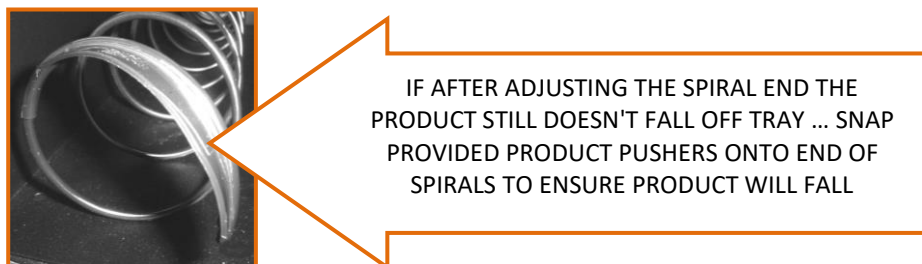

## LOADING BEVERAGE PRODUCTS

Push in on latches simultaneously on both sides of trays then pull forward until the tray stops to load.

Load product from front to back making sure all items fit freely between the spirals. Do not attempt to force oversized products into the spaces. Do not skip a space. Place the product on the bottom of the compartment on the spirals. To vend properly the product must be wider and taller than the diameter of the spiral being used. Undersized products may cause vend problems.

Load bottle products cap down in bottle trays as shown. Load cans horizontally. See page 11 to identify which selections are 16 oz. only and which selections are 12 oz. only

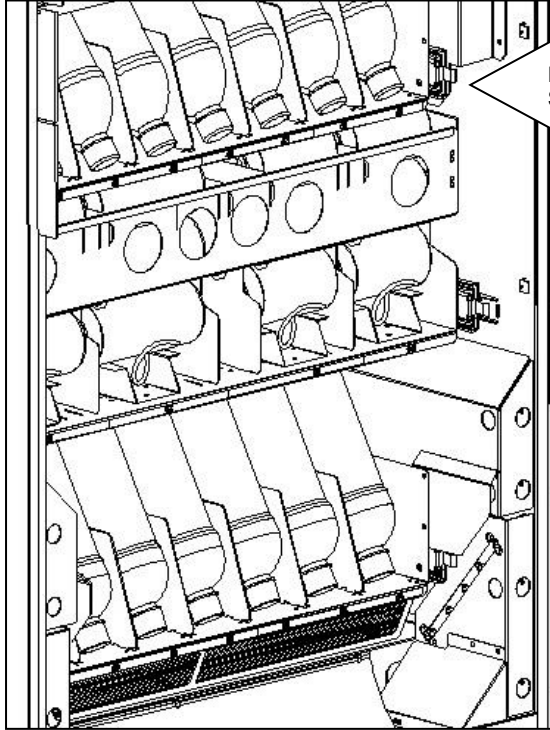

PUSH IN ON TRAY LATCHES ON BOTH SIDES AND PULL OUT TO LOAD

**IMPORTANT:**  
LOAD BOTTLED PRODUCTS  
CAP DOWN AND  
TILTED BACK AS SHOWN

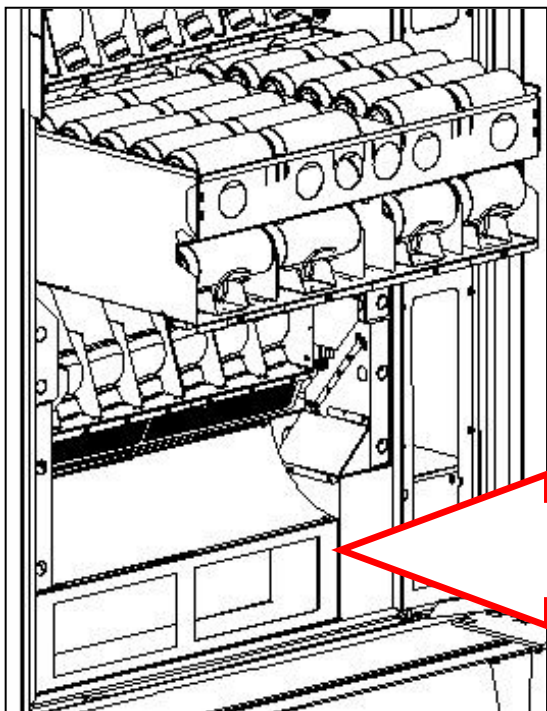

LOAD CANS HORIZONTALLY  
AS SHOWN WITH CAN TOP  
ORIENTED TO RIGHT  
(HINGE) SIDE

Pre-Cool Area  
For 12 oz. Cans



## LOADING COIN MECHANISM

The Coin Mechanism must be loaded with a minimum of one roll each of nickels, dimes and quarters in order for the vendor to operate properly. The coins need to be loaded into the coin mechanism by inserting them into the front coin insert. First enter the SERVICE MODE then enter the TUBE FILL MODE (See SERVICE MODE instructions, pg.12).

Each tube should be kept loaded with at least one roll of coins. This will ensure the coins are above the tube low level sensors. Once the tubes are loaded the Dollar Bill Validator (if equipped) will accept bills. If one or more of the coin tubes fall below the low level sensor the Dollar Bill Validator may stop accepting bills and the front display will light the "EXACT CHANGE ONLY" indicator LED.

Alternatively, you can load the coins into the slots above the respective coin tubes. This is not the preferred method. By using TUBE FILL mode the control board can then accurately determine coin levels.

On some Coin Mechanisms there are buttons above each tube to dispense the coins (may vary depending on which coin mechanism that is used). The coins can also be dispensed within the Service Mode described later.

More advanced and brand specific Coin Mechanism operating instructions can be obtained on the Service portion of the website listed at the beginning and end of this manual

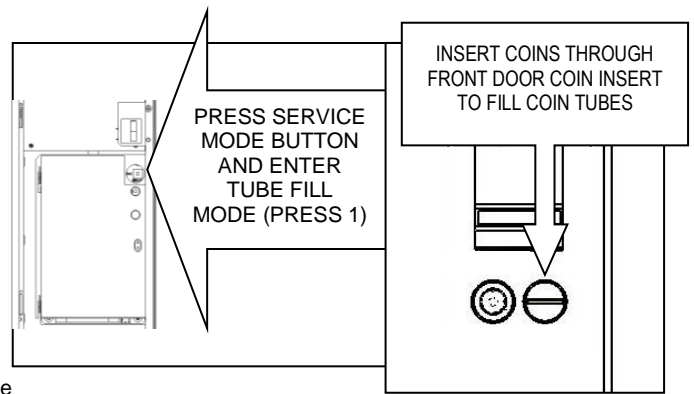

**NOTE: When using the Bill Validator, having the coin tubes full will provide the best bill acceptance operation.**

## BILL VALIDATOR OPERATION (OPTIONAL)

To remove the bills from the Dollar Bill Validator push the tab on the top of the bill box and lift up. To clear jams or cleaning unlatch lower unit as shown. Dollar Bill Validator cleaning instructions as well as more advanced service information can be obtained on the Service portion of the website listed at the beginning and end of this manual.

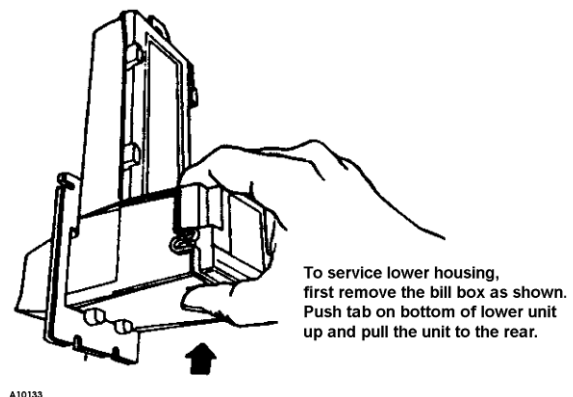
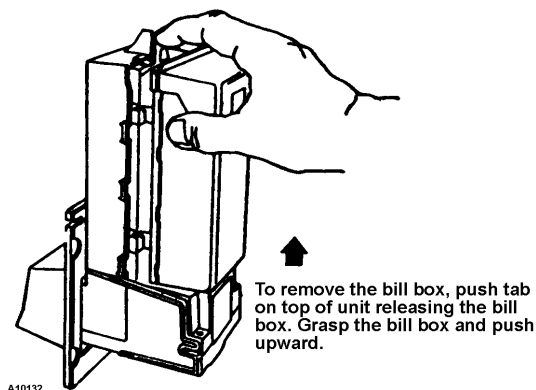

## SALES MODE

The vendor automatically defaults to Sales Mode after it is turned on. In the Sales Mode, the vendor accepts money deposits, pays out change and dispenses product to the customer.

## DISPLAY CREDIT - ELECTRONIC PRICING

This vendor is equipped with the Electronic Pricing feature. The customer verifies the price by pressing the selection number (i.e. 22) before inserting money. If a selection is made and credit has not been established, the price for that selection is displayed and will flash. When money or credit is accepted, then the amount of credit is displayed.

## "USE EXACT CHANGE" LED OPERATION

If the coin levels in the coin mechanism tubes are below the low-level sensors, the indicator LED next to "USE EXACT CHANGE" will illuminate. This indicates the Coin Mechanism does not have enough coins in the coin mech tubes to make change. This also indicates that the Dollar Bill Validator may be disabled until change can be made.

## "MAKE ANOTHER SELECTION" LED OPERATION

If a selection is made that is not available (i.e. 79 is not a good selection) or if there is a selection motor failure the indicator LED next to "MAKE ANOTHER SELECTION" will illuminate. If this is a motor failure the controller will display which motor has failed upon entering the Service Mode (described later in this manual).

## VEND CYCLE

If a selection is made and the accumulated credit is greater than or equal to the price of the selection, then a vend attempt will take place. If credit is less than the selection price, the price is displayed and will flash.

### Operation

1. The control system verifies the selection exists. If the selection is not available or failed previously the cycle stops and the "MAKE ANOTHER SELECTION" indicator LED is illuminated. The control system stores this error that will be displayed in the SERVICE MODE of operation. If no error is detected the vend cycle continues.
2. The Vend motor starts its rotation and a vend timer is started.
3. The selection motor rotates to the MOTOR HOME POSITION (as shown). The motor switch opens on the flat of motor cam.
4. If the home switch signal is sensed, then the Vend is considered successful. The amount of remaining credit is returned.
5. If there is no home switch signal detected and the vend timer has expired (approx. 10 seconds), then the Vend is considered failed. The vend motor is then shut down and "MAKE ANOTHER SELECTION" indicator light is turned on. The customer can press selection buttons to make another selection or they can press the coin return button to receive their money back. A failed motor must be test vended in the Service Mode to clear the failure.

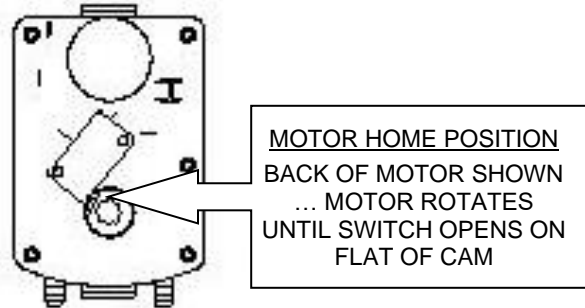

### Credit and Counters

#### After a successful vend ...

- The total non-resettable vend count is incremented by one and the total non-resettable cash value is incremented by the price of the vended selection.
- The total resettable vend count is incremented by one and the resettable total cash value is incremented by the price of the vended selection.
- NOTE: Test vends are not included in the counter totals.

## CHANGE RETURN

If after inserting credit the customer desires their money back the coin return button needs to be pressed. Upon insertion of a dollar bill and a change request is desired the vendor will do one of two things depending upon the setting of the FORCE VEND and BILL ESCROW features (operation as described later in the Service Mode section of this manual).

Two modes of change return operation ...

- If the bill is inserted and FORCE VEND is set to OFF and BILL ESCROW is set to ON when the customer requests change they will receive their bill back from the Dollar Bill Validator.
- If the bill is inserted and FORCE VEND is set to OFF and BILL ECROW is set to OFF when the customer requests change they will receive coin change back ... the vendor can be used as a bill changer. Operating the vendor in this manner is fine except the vendor may run low on coins more often and thus not be able to accept bills and may result in lost sales.

## DEX CAPABILITY (OPTION)

This vendor has the option of DEX capability. DEX is an acronym for **D**irect **EX**change. It is a vending industry communication standard which was originally created for the grocery industry. The option permits the operator to download with a handheld computer accounting data from the control board automatically. This data can then be used to accurately track cash accountability as well as evaluate the product marketing aspects within one vendor or many. The DEX option requires the purchase of extra harnessing, a handheld computer, and software to be used effectively. The data set which is defined includes, among others:

- Cash Count by selection
- Vend Count by selection
- Prices by selection
- Value of Coin in the Coin box
- Value of Bills in the bill validator

***The implementation of the DEX option may be beyond the needs of most operators but if more information is desired contact the service entity listed at the beginning and end of this manual***

# BEVERAGE AREA OPERATION

The Beverage Area motors are combined in a preset fixed pattern corresponding to the visible Live Display selections.

Notice that Selection 40 is actually tied to Three motors in the Top Bottle Tray ... Selection 43 is tied to the next two motors ... Selection 45 is tied to the next two motors in that tray. In the same manner, Selection 50 is tied to the first four motors in the Bottom Bottle Tray ... Selection 54 is then tied to motors 5-7 on that tray and so on.

The Control System will rotate through the tied motors within a selection. For example: when a customer selects Selection 50 the Control System will remember which motor was last vended and vend the next motor in that sequence. By vending in sequence this ensures a first-in / first-out rotation of product.

This combining of motor columns (Space-to-Sales) in varying quantities creates different capacities for each Selection. This combining of motors to selections is fixed and provides the following capacities by Selection:

Selection	Capacity	Totals
40	12 (20 oz. max.)	Total Bottle (or Cans) Capacity = <b>56</b>
43	8 (20 oz. max.)	
45	8 (20 oz. max.)	
50	16 (24 oz. max.)	
54	12 (24 oz. max.)	
60	32 (12oz. Cans)	Total Can Capacity = <b>80</b>
62	16 (12oz. Cans)	
63	16 (12oz. Cans)	
64	16 (12oz. Cans)	
Total		<b>136</b>

**THE SELECTIONS INSIDE THE MACHINE ARE LINKED TO THE 9 DISPLAYED SELECTIONS IN THE OUTER DOOR DISPLAY ... AS SHOWN BELOW**

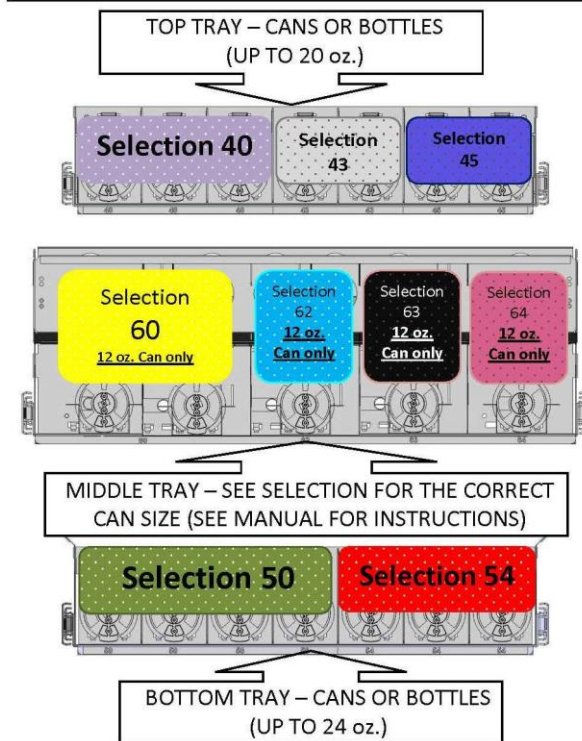

Though selections 40, 43, 45, 50 & 54 offer a great deal of versatility to dispense bottles and cans starting at 8.5oz and going up to the maximum volume noted, we cannot guarantee all bottles and cans will dispense due to the vast options available in the product marketplace.

## SOLD OUT VEND SEQUENCE

If a selection is made and the accumulated credit is greater than or equal to the price of the selection, then a vend attempt will take place. If credit is less than the selection price, the price is displayed and will flash.

The beverage area is equipped with IVend Sensor system. Upon selection of a beverage selection the control system determines whether there is a product available to vend. When a vend request is made the Control System monitors whether a beverage product breaks the IVend beam. This is a successful vend attempt and the normal vend cycle follows.

If the Control System does not sense IVend beam break by a beverage product then the Control System will attempt to rotate that selection motor one additional time. If IVend beam break is sensed at this time then this is considered a successful vend and the normal vend cycle follows. If upon this second attempt no IVend beam break is sensed then that motor is flagged as SOLD OUT. The Control System will then attempt to vend the next motor tied to that selection using the same two-rotation process. If IVend beam break is not sensed it then moves on to the next motor tied to that selection. It will continue this process until it has attempted a two-rotation process for each motor tied to that selection. If all attempts fail then the entire selection will be flagged as SOLD OUT and the "MAKE ANOTHER SELECTION" indicator LED is illuminated. The Control System will not attempt to vend any motor after it is flagged as SOLD OUT until the motors are reset to not SOLD OUT. The Control System will monitor the Door Switch located on the inside of the main outer door. Once the main outer door is opened the switch will open and the Control System will assume all beverages have been loaded and reset the flagged motors to active (not SOLD OUT).

Vend and Cash counters only will increment on successfully vended product. If the customer fails to receive their beverage they have the option of vending another product or receiving their money back (change).

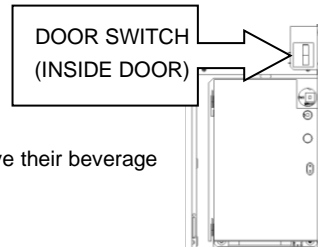

# SERVICE MODE

The Service Mode is used to access the programming features of the controller: Set Price, Test Vend, Retrieve Accounting Information, or Set Custom Program Settings. If credit exists when entering the Service Mode, it will be restored when the vendor is returned to Sales Mode.

## SERVICE MODE BUTTON

The Service Mode Button is located near the top right corner of the control board; it is a BLUE button just above the RED power LED. Press the button to access the Service Mode programming features. Press the button again to exit and return to Sales Mode. If no keypad button is pressed within 60 seconds while in Service Mode, the controller automatically exits to the Sales Mode.

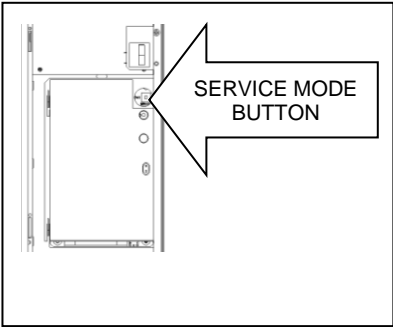

**IMPORTANT:** Press the service mode button only once to enter the service mode. A single audible beep will also be heard. In the service mode the motor count or an error message will be displayed until another key is pressed.

**DISPLAY**

Check the display after pressing the **Service Mode Button** and/or **Keypad Buttons**.

## KEYPAD OPERATION

In Service Mode buttons 0 thru 9 are used to access the various modes, menus and sub-menus as well as entering price values

The asterisk/star button \* is used to escape or back up within menus. Pressing the asterisk/star button \* repeatedly will back out of the Service Mode into the Sales Mode of operation.

The pound/number symbol # button is used to enter a menu, confirm or save a setting.

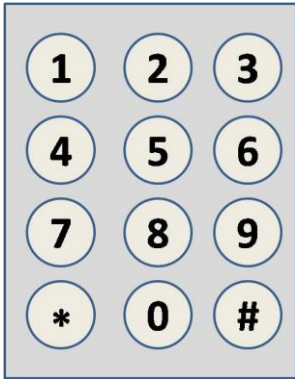

## PROGRAMMING

Press the Service Mode Button; check the display for instructions or choices while using the keypad.

### 1 PRESS 1 - TUBE FILL AND DISPENSE COINS MODES

#### TUBE FILL MODE

Tube Fill Mode counts coins as they are deposited and shows the deposited amount.

This permits the control system to accurately track coin tube inventories

STEP		DISPLAY
1.	Press Service Mode Button	38 (Motor Count is displayed)
2.	Press 1 and begin depositing coins	Totalized amount of entered coins
3.	Press * repeatedly to exit.	(Sales Mode)

#### DISPENSE COINS MODE

Dispense Coins Mode pays out coins from the coin mech coin tubes.

This mode will also display the current quantity of coins in the coin mech tubes.

STEP		DISPLAY
1.	Press Service Mode Button	38 (Motor Count is displayed)
2.	Press 1 to enter coin mode	.25
3.	Then Press 1 to dispense quarters	.25 - (25¢ coins)
4.	Or Press 2 to dispense dimes	.10 - (10¢ coins)
5.	Or Press 3 to dispense nickels	.05 - (5¢ coins)
6.	Or Press 4 to dispense more than 3 coin types	See Note below
7.	Press * repeatedly to exit.	(Sales Mode)

**\*\*Note:** For dispensing of coins on coin mechanisms with more than 3 tubes use keys greater in the same sequence as shown above.\*\*

## 2 PRESS 2 - MOTOR COUNT MODE

Motor Count Mode displays the total quantity of working motors.

STEP		DISPLAY
1.	Press Service Mode Button 	38 (Motor Count is displayed)
2.	Press <b>2</b> then wait ... counts available motors	38 (Motor Count is displayed)
3.	Press <b>*</b> to exit.	(Sales Mode)

## 3 OPTIONS MENU

This menu allows access to the following features:

**FORCE VEND**

**BILL ESCROW**

**MULTI VEND**

**FREE VEND**

**FAST CHANGE**

**OPTIC OPTION**

**POS MESSAGE**

**TEMPERATURE**

**KEYPAD BACKLIGHT** (not applicable in this model)

**DROP SENSOR SENSITIVITY** (not applicable in this model)

### 3.1

#### PRESS 3 THEN 1 - FORCE VEND OPTION

By pressing **3** then **1** this alternates between FORCE VEND ON (displayed as FrcY) or FORCE VEND OFF (displayed as Frcn).

This option will force the customer to complete a purchase once they have deposited money of any form.

STEP		DISPLAY
1.	Press Service Mode Button 	38 (Motor Count is displayed)
2.	Press <b>3</b>	OPtn
3.	then Press <b>1</b> ... repeat to toggle mode ON/OFF	FrcY or Frcn (default is FrcN)
4.	Press <b>#</b> to save setting.	FrcY or Frcn (last displayed setting)
5.	Press <b>*</b> repeatedly to exit.	(Sales Mode)

### 3.2

#### PRESS 3 THEN 2 - BILL ESCROW OPTION

By pressing **3** then **2** this alternates between BILL ESCROW ON (displayed as ESCY) or BILL ESCROW OFF (displayed as ESCn).

This option allows the last bill accepted to be returned, provided the bill acceptor is capable of such a feature.

STEP		DISPLAY
1.	Press Service Mode Button 	38 (Motor Count is displayed)
2.	Press <b>3</b>	OPtn
3.	then Press <b>2</b> ... repeat to toggle mode ON/OFF	ESCY or ESCn (default is ESCY)
4.	Press <b>#</b> to save setting.	ESCY or ESCn (last displayed setting)
5.	Press <b>*</b> repeatedly to exit.	(Sales Mode)

- **NOTE:** If you want the vendor to be used as a dollar bill changer (customer inserts bill then presses the coin return button to receive coin change for bill) then set FORCE VEND to OFF (Frcn) and BILL ESCROW to OFF (ESCn). Operating the vendor in this manner is fine except the vendor may run low on coins more often and thus not be able to accept bills and may result in lost sales.

3 . 3

**PRESS 3 THEN 3 - MULTI VEND OPTION**

By pressing 3 then 3 this alternates between MULTI VEND ON (displayed as NULY) or MULTI VEND OFF (displayed as NULn).

This option allows the customer to purchase more than one product if enough credit has been deposited. When this option is active, any credit remaining after a vend attempt is **not** automatically returned. At this point, the customer has the option of:

- Making another selection if there's enough credit OR
- Depositing more money OR
- Press the coin return button to receive remaining credit.

STEP		DISPLAY
1.	Press Service Mode Button 	38 (Motor Count is displayed)
2.	Press 3	OPtn
3.	then Press 3 ... repeat to toggle mode ON/OFF	NULY or NULn (default is NULn)
4.	Press # to save setting.	NULY or NULn (last displayed setting)
5.	Press * repeatedly to exit.	(Sales Mode)

- **NOTE: After 5 minutes any credit that is left on the display will disappear and is retained by the machine.**

3 . 4

**PRESS 3 THEN 4 - FREE VEND OPTION**

By pressing 3 then 4 this alternates between FREE VEND ON (displayed as FrEY) or FREE VEND OFF (displayed as FrEn).

This option makes all products available at no cost. No money is accepted by the vendor. The message "FREE" is displayed. This does not change the set prices. Once FREE VEND is set to OFF the selection prices revert back to the price set amounts.

STEP		DISPLAY
1.	Press Service Mode Button 	38 (Motor Count is displayed)
2.	Press 3	OPtn
3.	then Press 4 ... repeat to toggle mode ON/OFF	FrEY or FrEn (default is FrEn)
4.	Press # to save setting.	FrEY or FrEn (last displayed setting)
5.	Press * repeatedly to exit.	(Sales Mode)

3 . 5

**PRESS 3 THEN 5 - FAST CHANGE**

By pressing 3 then 5 this alternates between FAST CHANGE ON (displayed as FChY) or FAST CHANGE OFF (displayed as FChn).

This option makes allows the vending machine to give change immediately after the customers makes a selection. If **FAST CHANGE** is ON, it will override the Multi Vend feature.

**NOTE: if "OPTICS" is turned ON the amount of the product will display until a product drops.**

STEP		DISPLAY
1.	Press Service Mode Button 	38 (Motor Count is displayed)
2.	Press 3	OPtn
3.	then Press 5 ... repeat to toggle mode ON/OFF	FChY or FChn (default is FChn)
4.	Press # to save setting.	FChY or FChn (last displayed setting)
5.	Press * repeatedly to exit.	(Sales Mode)

**3 . 6**

**PRESS 3 THEN 6 - OPTICS OPTION**

By pressing **3** then **6** this alternates between OPTICS ON (displayed as oPtY) or OPTICS OFF (displayed as oPtn).

**IMPORTANT:** This option must be set to oPtY for this model. This along with the Space-to-Sales setting STS9 turns on the vend sensor for the beverage selections.

STEP		DISPLAY
1.	Press Service Mode Button 	38 (Motor Count is displayed)
2.	Press <b>3</b>	OPtn
3.	then Press <b>6</b> ... repeat to toggle mode ON/OFF	oPtY or oPtn (Must be set to oPtY)
4.	Press <b>#</b> to save setting.	Make sure displays oPtY
5.	Press <b>*</b> repeatedly to exit.	(Sales Mode)

**3 . 7**

**PRESS 3 THEN 7 – POS MESSAGE**

By pressing **3** then **7** this alternates between POS ON (displayed as POSY) or POS OFF (displayed as POSn).

Turn OFF (or ON) the default display message.

NOTE: The display message for a drink machine is "ICE COLD". All others the message is 0.00

STEP		DISPLAY
1.	Press Service Mode Button 	38 (Motor Count is displayed)
2.	Press <b>3</b>	OPtn
3.	Press <b>7</b>	POSY
4.	Press <b>7</b> ...repeat to toggle mode ON/OFF.	POSn
5.	Press <b>#</b> to save setting.	POSn
6.	Press <b>*</b> repeatedly to exit.	(Sales Mode)

**3 . 8**

**PRESS 3 THEN 8 – TEMPERATURE SETPOINT**

The factory default setting for this machine is 36F. This temperature may be adjusted, however it is *not* recommended. The temperature has been set according to NAMA specifications for optimal operation and/or product safety.

STEP		DISPLAY
1.	Press Service Mode Button 	38 (Motor Count is displayed)
2.	Press <b>3</b>	OPtn
3.	Press <b>8</b> to view current temperature set point	36
4.	Press <b>8</b> repeatedly to change the temperature set point Note: temperature will increase to 75 then start over at 34	37...
5.	Press <b>#</b> to save	36
6.	Press <b>*</b> repeatedly to exit.	(Sales Mode)

**MODES **3 . 9** AND **3 . 0** ARE NOT APPLICABLE TO THIS MODEL**

## 4 PRESS 4 - VENDOR CONFIGURATION MENU

This menu allows access to the following features:

ITEM (can/bottle) - (not applicable in this model)

ROW (snack/can/bottle) - (not applicable in this model)

ALL (snack/can/bottle)

SPACE-TO-SALES (STS)

ADVANCED CONFIGURATION - (not applicable in this model)

**NOTE: This model requires that the entire vendor be set to SNACK ... to reset this back to factory setting:**

4 . 3

### PRESS 4 THEN 3 - VENDOR CONFIGURATION

By pressing 4 then 3 repeatedly this sets vendor configuration ... must be set on SnAc

This sets the operating mode of the vendor.

**IMPORTANT: This model should always be set to a SNACK (SnAc) configuration.**

STEP		DISPLAY
1.	Press Service Mode Button 	38 (Motor Count is displayed)
2.	Press 4	Cbs
3.	then Press 3 until displays SnAc	ALL ... SnAc
4.	Press # to save setting.	Make sure displays SnAc
5.	Press * repeatedly to exit.	(Sales Mode)

4 . 6

### PRESS 4 THEN 6 - VENDOR SPACE-TO-SALES

By pressing 4 then 6 repeatedly sets vendor space-to-sales ... must be set to STS9.

STS9 is for the High Capacity Can tray (middle tray) with 4 selections (2 – 16oz cans and 2 – 12oz cans selection) having IVend sensor system for beverage area.

This sets the Space-to-Sales mode of the vendor.

**IMPORTANT: This model should always be set to STS9 configuration.**

STEP		DISPLAY
1.	Press Service Mode Button 	38 (Motor Count is displayed)
2.	Press 4	Cbs
3.	then Press 6 until STS9 is displayed	STS9
4.	Press # to save setting.	Make sure displays STS9
5.	Press * repeatedly to exit.	(Sales Mode)

4 . 0 . 7

### PRESS 4 THEN 0 THEN 7 – TEMP

This mode allows the board to electronically control the refrigeration system.

STEP		DISPLAY
1.	Press Service Mode Button 	38 (Motor Count is displayed)
2.	Press 4	Cbs
3.	Press 0	PASS
4.	Enter Password (default 2314)	ACFG
5.	Press 7 repeatedly until CoLd is displayed	CoLd
6.	Press # to save	36
7.	Press * repeatedly to exit.	(Sales Mode)



## 5 PRESS 5 - PRICING

(The maximum price that can be set is \$99.95)

- ITEM — **set price** by individual selections
- ROW— set price by tray
- ALL ITEMS — **set price by** entire vendor.
- COUPONS — **set coupon value** by Item, Row, or ALL
- TOKENS — **set token value** by Item, Row, or ALL

### 5.3

#### PRESS 5 THEN 3 - PRICE ALL SELECTIONS

This menu allows you to set the price of every item all at once.

**Time Saving Tip:**

*Instead of setting the price of each item one at a time, it is much faster to set the common price of the entire vendor; then go back and set the price of each item or row.*

STEP		DISPLAY
1.	Press Service Mode Button 	38 (Motor Count is displayed)
2.	Press <b>5</b>	Prc
3.	Press <b>3</b>	ALL
4.	Enter price (i.e. 50 = .50)	0.50
5.	Press <b>#</b> to save.	0.50
6.	Press <b>*</b> repeatedly to exit.	(Sales Mode)

### 5.2

#### PRESS 5 THEN 2 - PRICE BY ROW / TRAY

Use this menu to set the price of a tray/row all at the same time.

**Time Saving Tip:**

*Instead of setting the price of one item at a time, set the common price of a Tray/Row, then go back and set the price of each item.*

STEP		DISPLAY
1.	Press Service Mode Button 	38 (Motor Count is displayed)
2.	Press <b>5</b>	Prc
3.	Press <b>2</b>	ro -
4.	Enter tray/row number and price <i>Example: Top row=1, row below top row=2, etc. Program will then request input of the next Row.</i>	ro 01 0.50
5.	Press <b>#</b> to save.	ro 01 0.50
6.	Press <b>*</b> repeatedly to exit.	(Sales Mode)

### 5.1

#### PRESS 5 THEN 1 - PRICE BY SELECTION

This menu allows price setting by each selection.

STEP		DISPLAY
1.	Press Service Mode Button 	38 (Motor Count is displayed)
2.	Press <b>5</b>	Prc
3.	Press <b>1</b>	-- (prompted to enter selection)
4.	Enter selection and price	10 0.50
5.	Press <b>#</b> to save. The program will then request input of the next selection number and you can continue to enter prices. Each time Press <b>#</b> to save.	Item 11 0.50
6.	Press <b>*</b> repeatedly to exit.	(Sales Mode)

5 . 4







**PRESS 5 THEN 4 - SET COUPON VALUE**

This mode allows the operator to designate the values of "free vend" coupons that the bill validator has been programmed to accept. The control board can have 5 different coupons each having a different value. After one coupon is accepted, further coupons will not be accepted until a successful vend has taken place.

**NOTE:**

*This option requires a coupon programmed bill validator. The coupons are special order. The specially programmed bill validator and special coupons can be purchased from the parts entity listed at the beginning and end of this manual.*

*If no coupon value is set, coupons will be shown as free vends.*

STEP		DISPLAY
1.	Press Service Mode Button 	38 (Motor Count is displayed)
2.	Press 	Prc
3.	Press 	CPn
4.	Press  for Coupon 1... the set value is shown	CPn1 0.00
5.	Enter desired Coupon1 Value ... setting to 0.00 will set Coupon Value one Free Vend	1.50
6.	Press  to save.	1.50
7.	Press  2 times to add values for Coupons 2-5 or Press  repeatedly to exit to Sales Mode.	

5 . 5







**PRESS 5 THEN 5 - SET TOKEN VALUE**

This mode allows the operator to designate the values of "free vend" tokens.. The control board can have 5 different tokens each having a different value.

**NOTE:**

*This option requires a specially tuned coin mechanism. The tokens are special order. The specially tuned coin mechanism and special tokens can be purchased from the parts entity listed at the beginning and end of this manual.*

*If no token value is set, tokens will be shown as free vends.*

STEP		DISPLAY
1.	Press Service Mode Button 	38 (Motor Count is displayed)
2.	Press 	Prc
3.	Press 	thn
4.	Press  for Token 1 ... the set value is shown	thn1 0.00
5.	Enter desired Token1 Value ... setting to 0.00 will set Token Value one Free Vend	1.50
6.	Press  to save.	1.50
7.	Press  2 times to add values for Tokens 2-5 or Press  repeatedly to exit to Sales Mode.	

## 6 PRESS 6 - ACCOUNTING MODE

- This mode accesses the submenus that displays or resets data for various types of cash and vend totals. Counts can be viewed by individual items, rows or as the whole vendor. The counters rollover at 999,999 vends and \$999,9999.99 sales.
  - **Historical Totals:** These are the counts since the initialization of the vendor. They cannot be reset.
  - **Resettable Totals:** These are totals since the last reset. These can be reset at any time. You have the option to reset just an item, row or the whole vendor.
- **Note: Clearing counts only clears the resettable counters. Clearing by item and row will only clear the item or row entered.**

Description of counters:

- Historical Vend Count: Total number of vends ever
- Historical Cash Count: Total cash value ever sold
- Resettable Vend Count: Total number of vends since counters were last reset/cleared
- Resettable Cash Count: Total cash value since counters were last reset/cleared

## 6 . 3

### PRESS 6 THEN 3- ACCOUNTING TOTALS FOR ALL SELECTIONS - ENTIRE VENDOR

This menu displays the total sales values and total vend count for the entire vendor.

STEP		DISPLAY
1.	Press Service Mode Button 	38 (Motor Count is displayed)
2.	Press 6	Acct
3.	Press 3 The Historical count will be shown	All 10
4.	Press 1 Historical vend count	10
5.	Press 2 Historical cash value	10.00
6.	Press 3 Resettable count	10
7.	Press 4 Reset Cash	10.00
8.	Press 5 Historical Card Value	0.00
9.	Press 6 Historical 2nd Vends	0
10.	Press 7 Reset Card	0.00
11.	Press 8 Reset 2nd Vends	0
12.	Press 0 to clear all selections	Clr?
13.	Press 0 to confirm clear <b>Confirming clear will clear the resettable counts for ALL ITEMS.</b>	Clrd
14.	Press * 4 times to exit	0.00

6.2

**PRESS 6 THEN 2 - ACCOUNTING TOTALS FOR A ROW/TRAY**

This menu displays the total sales values and total vend count for a row/tray in the vendor.

STEP		DISPLAY
1.	Press Service Mode Button 	38 (Motor Count is displayed)
2.	Press <b>6</b>	Acct
3.	Press <b>2</b> to enter row Enter the row number	ro-
4.	Press <b>1</b> Historical vend count	10
5.	Press <b>2</b> Historical cash value	10.00
6.	Press <b>3</b> Resettable count	10
7.	Press <b>4</b> Reset Cash	10.00
8.	Press <b>5</b> Historical Card Value	0.00
9.	Press <b>6</b> Historical 2nd Vends	0
10.	Press <b>7</b> Reset Card	0.00
11.	Press <b>8</b> Reset 2nd vends	0
12.	Press <b>0</b> to clear Resettables	Clr?
13.	Press <b>0</b> to confirm clear ( <b>ONLY For that row</b> )	Clrd
14.	Press <b>*</b> to enter another row or press <b>*</b> 4 times to exit	Sales Mode

6.1

**PRESS 6 THEN 1 - ACCOUNTING TOTALS FOR A SELECTION**





This menu displays the total sales value and total vend count for an individual selection.

STEP		DISPLAY
1.	Press Service Mode Button 	38 (Motor Count is displayed)
2.	Press <b>6</b>	Acct
3.	Press <b>1</b> to enter an item Enter the item number	-- 14
4.	Press <b>1</b> Historical vend count	10
5.	Press <b>2</b> Historical cash value	10.00
6.	Press <b>3</b> Resettable count	10
7.	Press <b>4</b> Reset. Cash	10.00
8.	Press <b>5</b> Historical Card Value	0.00
9.	Press <b>6</b> Historical 2nd Vends	0
10.	Press <b>7</b> Reset. Card	0.00
11.	Press <b>8</b> Reset 2nd vends	0
12.	Press <b>0</b> to clear Resettables ( <b>ONLY for that item</b> )	Clr?
13.	Press <b>0</b> to confirm clear	Clrd 0.00

## 7 PRESS 7 – ADVANCED OPTIONS

### 7.4 EXACT CHANGE

The amount of coins left in coin mech when "Use Exact Change" light comes on



	STEP	DISPLAY
1.	Press Service Mode Button 	38 (Motor Count is displayed)
2.	Press  Enter Password (default 2314)	PASS AdV
3.	Press 	EChG 0.00
4.	Enter the amount for exact change	0.00
5.	Press  to save	1.00
6.	Press  repeatedly to exit.	(Sales Mode)

See GVC1 programming manual P/N 4216961 for more information on these options.

## 8 PRESS 8 - TEST VEND SELECTION MODE

Use this menu to test vend individual selection motors. The selection will display during the test vend. If tests vend fails the indicator LED next to the "MAKE ANOTHER SELECTION" will illuminate.

**NOTE: Test vends are not included in the ACCOUNTING MODE counter totals.**

	STEP	DISPLAY
1.	Press Service Mode Button 	38 (Motor Count is displayed)
2.	Press 	--
3.	Press selection number on keypad and wait	10
4.	Repeat step 3 for other selections.	
5.	Press  repeatedly to exit.	(Sales Mode)





## 9 PRESS 9 - TEST VEND ALL SELECTIONS MODE

This menu will test vend all selection motors. Each selection will display as it vends. If a test vend attempt on a particular motor fails, then the indicator LED next to the "MAKE ANOTHER SELECTION" will illuminate.

**NOTE:** By entering this mode each selection motor will turn ... any product loaded will be vended ... if the door is open, be prepared to catch product as it is vended.

**NOTE:**

Pressing  at any time will stop the test. If a selection motor does not stop at home test that individual selection to return it to the home position

	STEP	DISPLAY
1.	Press Service Mode Button 	38 (Motor Count is displayed)
2.	Press  and wait. The motor selection number will display while it is being tested.	10
3.	Press  to stop the test	38
4.	Press  repeatedly to exit.	(Sales Mode)

## 0 PRESS 0 - DIAGNOSTICS MODE

0.1

### PRESS 0 THEN 1 - VENDOR SELF-DIAGNOSTIC TEST

This menu is used to perform a vendor self-diagnostics test. Monitor the display for possible error messages. Record errors as they are displayed.

STEP		DISPLAY
1.	Press Service Mode Button 	38 (Motor Count is displayed)
2.	Press <b>0</b>	diAG
	Press <b>1</b> to start test	<b>tESt</b> (test start) <b>E##</b> (failed motor(s)) <b>CtL</b> (control board test) <b>ChSu</b> (check sum control board test) <b>Cn</b> (Coin Mechanism test) <b>biLL</b> (bill validator test - (when installed - option)) <b>rdr1</b> (card reader test - (when installed - option))
3.	Press <b>*</b> repeatedly to exit.	(Sales Mode)

Possible Error Codes		
Displayed Error	Description	Possible Remedy
<b>E## or ESc oPEn</b> (displayed when entering Service Mode)	Selection Motor Diagnostic <b>##</b> = motor that has failed or <b>ESc oPEn</b> - Coin Return Motor failed	Check motor connection, test vend motor
<b>Ctl</b>	Control Board input Error <b>Good</b> or <b>SI</b> (keypad stuck)	Keypad stuck error: check keypad connection, test all buttons, replace keypad
<b>ChSu</b>	Control board checksum error <b>Good</b> or <b>Fail</b>	Upon <b>Fail</b> turn power off ... wait 30 seconds and turn power back on ... continues to <b>Fail</b> - replace control board
<b>Cn</b>	Coin Mechanism Diagnostic <b>Good</b> or <b>Chg3</b> (communication error)	turn power off ... check coin mechanism connection ... wait 30 seconds and turn power back on ... continues to display <b>Chg3</b> - replace coin mechanism
<b>biLL</b> (when installed - option)	Bill Validator Diagnostic <b>Good</b> or <b>Bil7</b> (communication error)	turn power off ... check bill validator connection ... wait 30 seconds and turn power back on ... continues to display <b>Bil7</b> - replace bill validator
<b>rdr1</b> (when installed - option)	Card Reader Diagnostic <b>Good</b> or <b>rdr8</b> (communication error)	turn power off ... check card reader connection ... wait 30 seconds and turn power back on ... continues to display <b>rdr8</b> - replace card reader
<b>tS1C</b>	The temperature sensor or harness is considered to have an electrical short.	Check sensor and sensor harness for shorted condition. Check for sensor readings. Replace sensor if necessary
<b>tS1o</b>	The temperature sensor or harness is considered to have an open electrical connection	Check sensor and sensor harness for open connections. Check for sensor readings. Replace sensor if necessary

Possible Error Codes		
Displayed Error	Description	Possible Remedy
Opt	Snack area optical vend sensor is blocked or disconnected or out of position	Check for delivery box product blockage, wire harness connections or optical sensor board out of position. The red light on sensor board close to the payment system is ON when the sensor boards are in place and not blocked. Verify sensor operation with service mode optics test and a test vend.
Opt2	Drink area optical vend sensor is blocked or disconnected or out of position	Check for delivery area product blockage, wire harness connections or optical sensor board out of position. The red light on sensor board at inner door hinge side is ON when the sensor boards are in place and not blocked. Verify sensor operation with service mode optics test and a test vend.

**For additional trouble shooting assistance contact the service entity listed at the beginning and end of this manual.**

0.2

**PRESS 0 THEN 2 - TEST RELAY**

Testing of Relays - This menu provides functions that allow the operator to test the operation of the refrigeration compressor.

RELAY1 - Refrigeration Compressor.

STEP		DISPLAY
1.	Press Service Mode Button 	38 (Motor Count is displayed)
2.	Press 0	Diag
3.	Press 2	r1Y
4.	Press 1 to toggle Relay 1 ON/OFF	rL1n

0.3

**PRESS 0 THEN 3 - CONTROL BOARD LOG (ENGINEERING DIAGNOSTIC MENU - TECHNICIAN ONLY!)**

0.4

**PRESS 0 THEN 4 - COIN REJECT RATE**





This mode tracks the percentage of coins that have been rejected by the coin mechanism. This will be reset when ALL counters are reset in the ACCOUNTING MODE. A high reading (> 10%) may indicate an unclean or damaged coin mechanism.

STEP		DISPLAY
1.	Press Service Mode Button 	38 (Motor Count is displayed)
2.	Press 0	Diag
3.	Press 4 to view reject percentage	CrJ
4.	Press * repeatedly to exit.	(Sales Mode)

0 . 5

**PRESS 0 THEN 5 - BILL REJECT RATE**



This mode tracks the percentage of bills that have been rejected by the bill validator. This will be reset when ALL counters are reset in the ACCOUNTING MODE. A high reading (> 15%) may indicate an unclean or damaged bill validator.

STEP		DISPLAY
1.	Press Service Mode Button 	38 (Motor Count is displayed)
2.	Press 	Diag
3.	Press  to view reject percentage	brJ
4.	Press  repeatedly to exit Mode.	(Sales Mode)

0 . 6

**PRESS 0 THEN 6 – IVEND ALIGNED (UPPER/SNACK)**





Indicates when iVend™ vend delivery sensors for snack area are in alignment

STEP		DISPLAY
1.	Press Service Mode Button 	38 (Motor Count is displayed)
2.	Press 	Diag
3.	Press  to check I-vend alignment	“Good” or “No”
4.	Press  repeatedly to exit.	(Sales Mode)

0 . 0 . 6

**PRESS 0 THEN 0 THEN 6 – IVEND ALIGNED (LOWER/DRINK)**

Indicates when iVend™ vend delivery sensors for drink area are in alignment

STEP		DISPLAY
1.	Press Service Mode Button 	38 (Motor Count is displayed)
2.	Press 	Diag
3.	Press 	Prph
4.	Press  to check I-vend alignment	“Good” or “No”
5.	Press  repeatedly to exit.	(Sales Mode)

**ALL OTHER OPTIONS WITHIN (MODE 0) ARE NOT APPLICABLE TO THIS MODEL**



## PREVENTATIVE MAINTENANCE

**CAUTION: ALWAYS DISCONNECT POWER SOURCE BEFORE CLEANING OR SERVICING!**

**WARNING: THIS VENDOR MUST NOT BE CLEANED WITH A WATER JET!**

### ONCE A MONTH

- **Clean Screen under cabinet**
- **Keep refrigeration compartment free of dust, lint, and debris**
- **Clean cabinet interior**
  - Wash with a mild detergent and water, rinse and dry thoroughly.
  - Odors may be eliminated by including baking soda or ammonia in the cleaning solution.
  - Plastic parts may be cleaned with a quality plastic cleaner.
  - The vend mechanism must be kept clean. Any build-up can cause the mechanisms to malfunction.
  - Do not get the cleaning solution on electrical components.
  - To insure proper vending keep delivery slide area free of dirt and sticky substances.
- **Clean Cabinet Exterior**
  - Wash with a mild detergent and water, rinse and dry thoroughly.
  - Clean occasionally with a quality car wax or cleaner.

## PARTS ORDERING PROCEDURE

When ordering parts, include the following:

- Model and serial number of the vendor
- Shipping address
- Address where the invoice should be sent
- Quantity of parts ordered
- Any special shipping instructions
- Desired carrier: air or air special, truck, parcel post, or rail.
- Signature and ordering date.
- If a purchase order is used, be sure it is visible and legible

Please be sure that you refer to the correct part number, vendor model number, and vendor serial number when ordering. These can be confirmed by checking the parts manual found. Further information can be obtained on the Service portion of the website listed at the beginning and end of this manual.

**NOTE: "Left" or "Right" when used in the name or description of the part are determined while facing the front of the vendor with the door closed.**

## BEFORE CALLING FOR SERVICE

Please check the following:

- If the power is turned on at the fuse box, is the vendor the only thing that does not work?
- Is the vendor plugged directly into the outlet?
- Is the circuit breaker at the fuse box reset?

**WARNING: DO NOT USE EXTENSION CORDS!**

**NOTE: Please have your Model and Serial Number available when you call.**



**NOTES:**

*The contents of this publication are presented for informational purposes only, and while every effort has been made to ensure their accuracy, they are not to be construed as warranties or guarantees, express or implied, regarding the products or services described herein or their use or applicability. We reserve the right to modify or improve the designs or specifications of such products at any time without notice.*



**VendNet™**  
 165 North 10th Street  
 Waukee, Iowa 50263  
 United States of America



	USA & Canada	International
Service	<b>(800) 833-4411</b>	<b>(515) 274-3641</b>
Parts	<b>(888) 259-9965</b>	
Email	<b>vendnet@vendnetusa.com</b>	
Web Site	<b>www.vendnetusa.com</b>	